

OPTOTRONIC® LED Power Supply OT40W Programmable - Technical Specifications



ELECTRICAL SPECIFICATIONS		
Input		
Input Voltage (VAC)	120V-277V (+/- 10%)	
Frequency Range (Hz)	50 – 60 Hz (+/- 10%)	
	120V	277V
Input Current (A)	0.42	0.17
THD @ Full load	< 10%	< 20%
Power Factor @ Full load	>0.9	>0.9
Efficiency @ Full load	> 85%	>85%
Inrush Current (A _{pk})	11.7	27.1
Line Regulation	< 3%	
Stand-by Power (W)	< 1W	
Output		
Output Current (mA)	400-1400mA ⁽¹⁾ (1mA step) (Programmable)	
Output Voltage (VDC)	10-55VDC (Power limited)	
Output Ripple Current	<20% @ 1400mA	
Max. Output power (W)	40W (model dependent)	
LED Power-up time	< 1sec	
Load Regulation	<5%	
Over voltage protection	Yes	
Output short-circuit protection	Yes, non- latching	
LED load temperature protection	Yes, current reduction	

GENERAL INFORMATION	
Item Number(s)	79441 (1 %, J-type) 79442 (1 %, F-type) 79448 (10 %, F-type) 79449 (10 %, J-type)
Type	Constant Current
Output Power	40W (Max.)
Programming tool	51645- OT Programmer
Software	Download

ELECTRICAL SPECIFICATIONS	
Dimming	
Dimming Control	0 – 10V (Isolated)
Dimming Range	1 – 100% & 10-100% ⁽²⁾
Dimming Type	Analog , PWM
Frequency	≥ 1kHz (PWM)
Dimming Input Isolation	2.5KV
Source/Sink Current	1mA
LED thermal protection (NTC)	
NTC value	≤ 25kΩ, 15 kΩ @ 25 °C typical
Output level minimum	User defined

ENVIRONMENTAL SPECIFICATIONS	
Ambient Operating Temperature	-35 °C to 50 °C
Max. Case Temp. (Tc)	75°C (50kHrs) ⁽³⁾ 85°C (20kHrs)
Max. Storage Temp.	75°C
Max. Relative Humidity (%)	85% non condensing
Transient Protection	NEMA SSL1 - 2010 Non-Roadway 2.5KV
UL Environmental Rating	Dry & Damp
UL File number	E320395 //Class TL
IP Rating	IP20
EMI Compliance	FCC Part 15 Class A
Sound Rating	Class A

1- The output is in PWM mode under 350mA.

2-The lowest output current is 10mA and the minimum percentage of dimming is dependent on the programmed output current of the driver

3- Warranty applicable only at 75°C



WIRING DIAGRAM

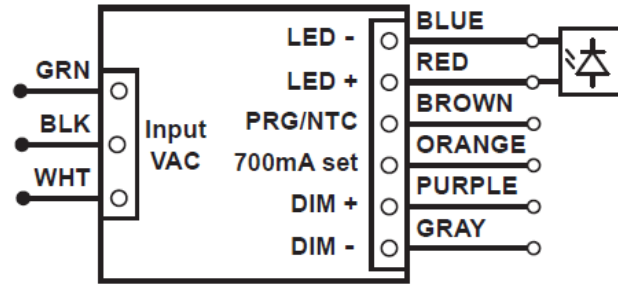

Note 1: Connect **700mA set (ORANGE)** to **LED - (BLUE)** to set output current to **700 mA**

Note 2: Maximum suggested remote mounting distance is 16 feet. For additional information on further distances and EMI compliance reference OPTOTRONIC Technical Guide LED258.

Note3: Wire extraction tool is needed to extract the wires from the connectors. (WAGO Part#- 210-719)

MECHANICAL SPECIFICATIONS

Housing	F- Style
Length	4.3" (109mm)
Width	2.4" (61.1mm)
Height	1.2" (27.5mm)
Mounting Length	4.5" (115mm)
Mounting width	2.4" (61.1mm)

MECHANICAL SPECIFICATIONS

Housing	J-Style
Length	4.2" (106mm)
Width	2.4" (61.1mm)
Height	1.2" (27.5mm)
Mounting Length (PEM studs)	2.0" (50.8mm)
Mounting width	2.4" (61.1mm)

MECHANICAL DIAGRAM

F- Style Housing

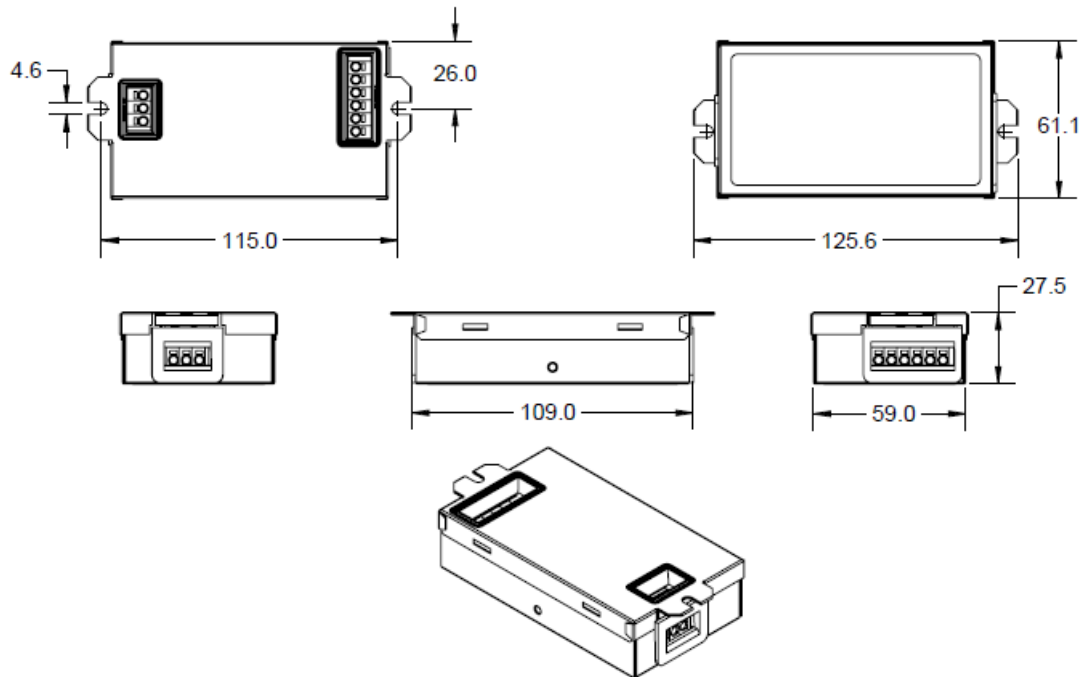

J- Style Housing

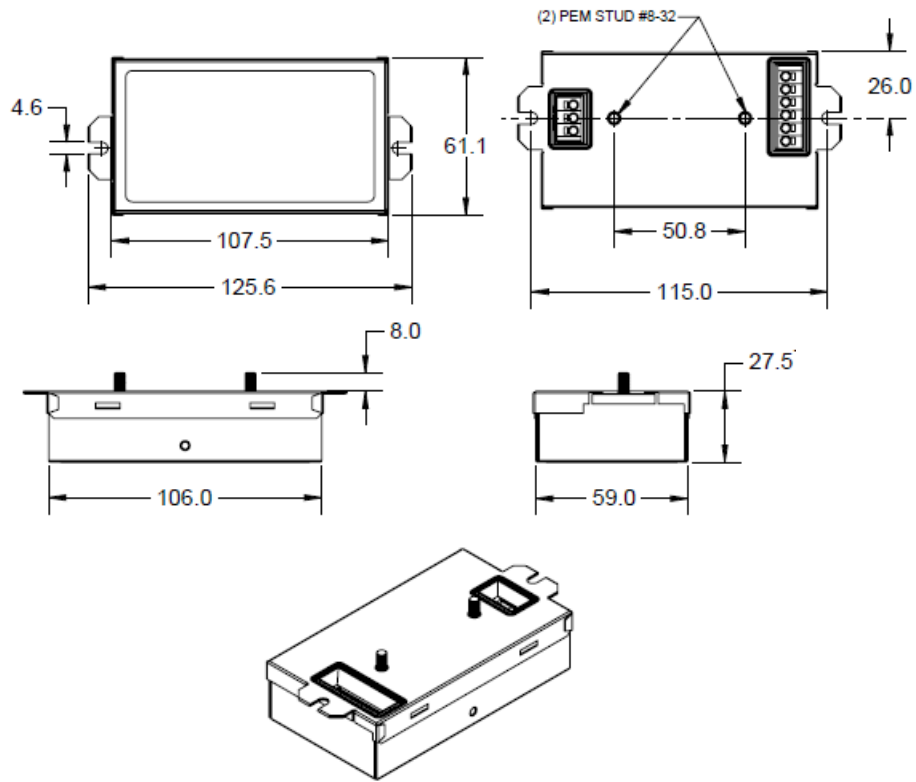

OPERATING RANGE

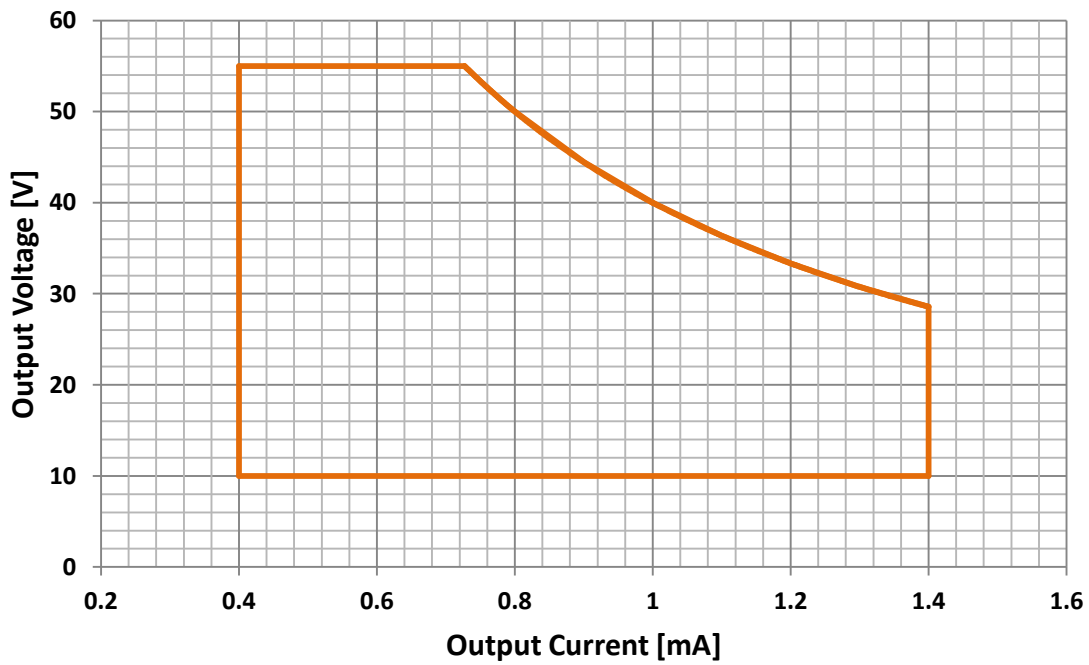

DIMMING CURVE

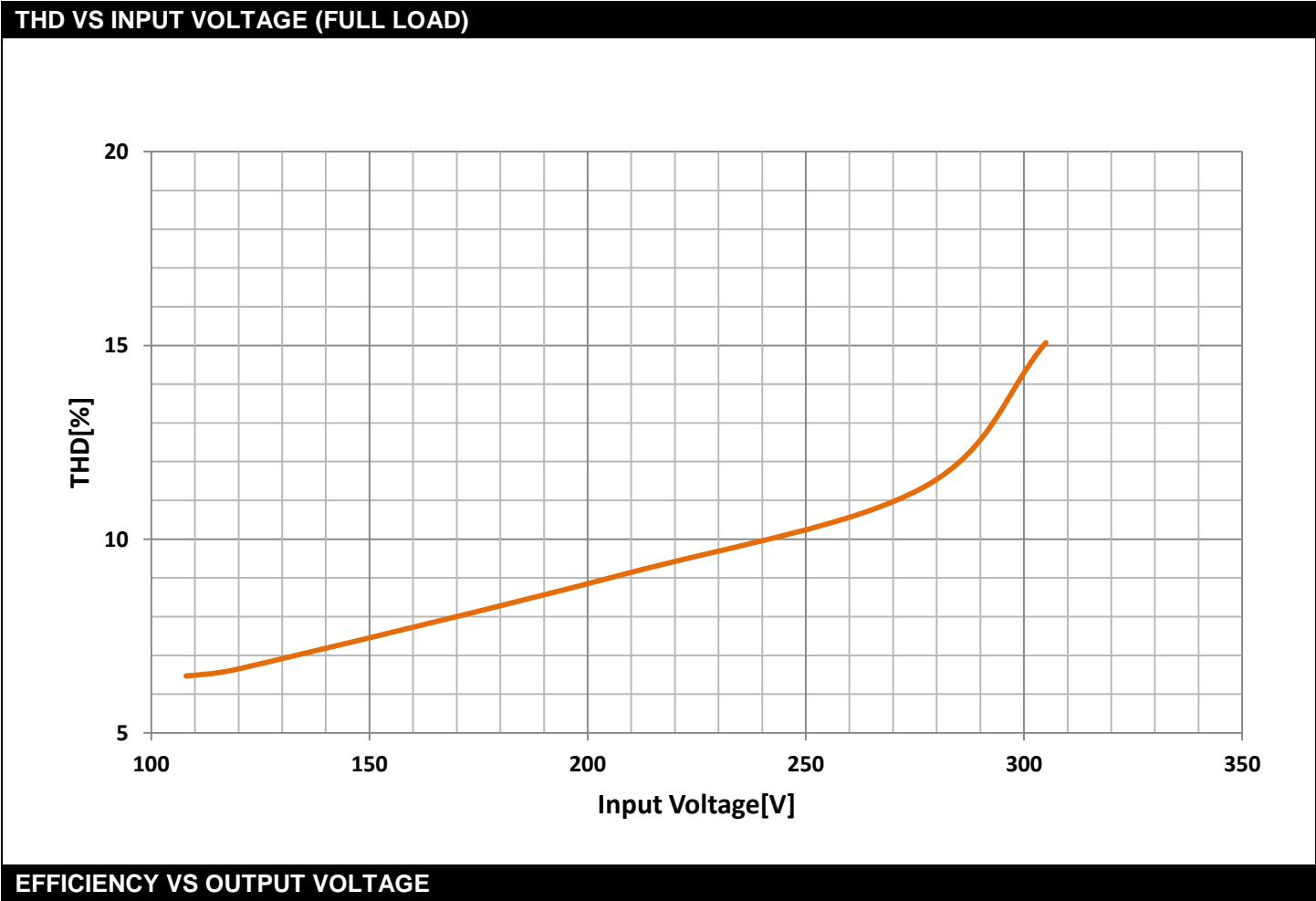
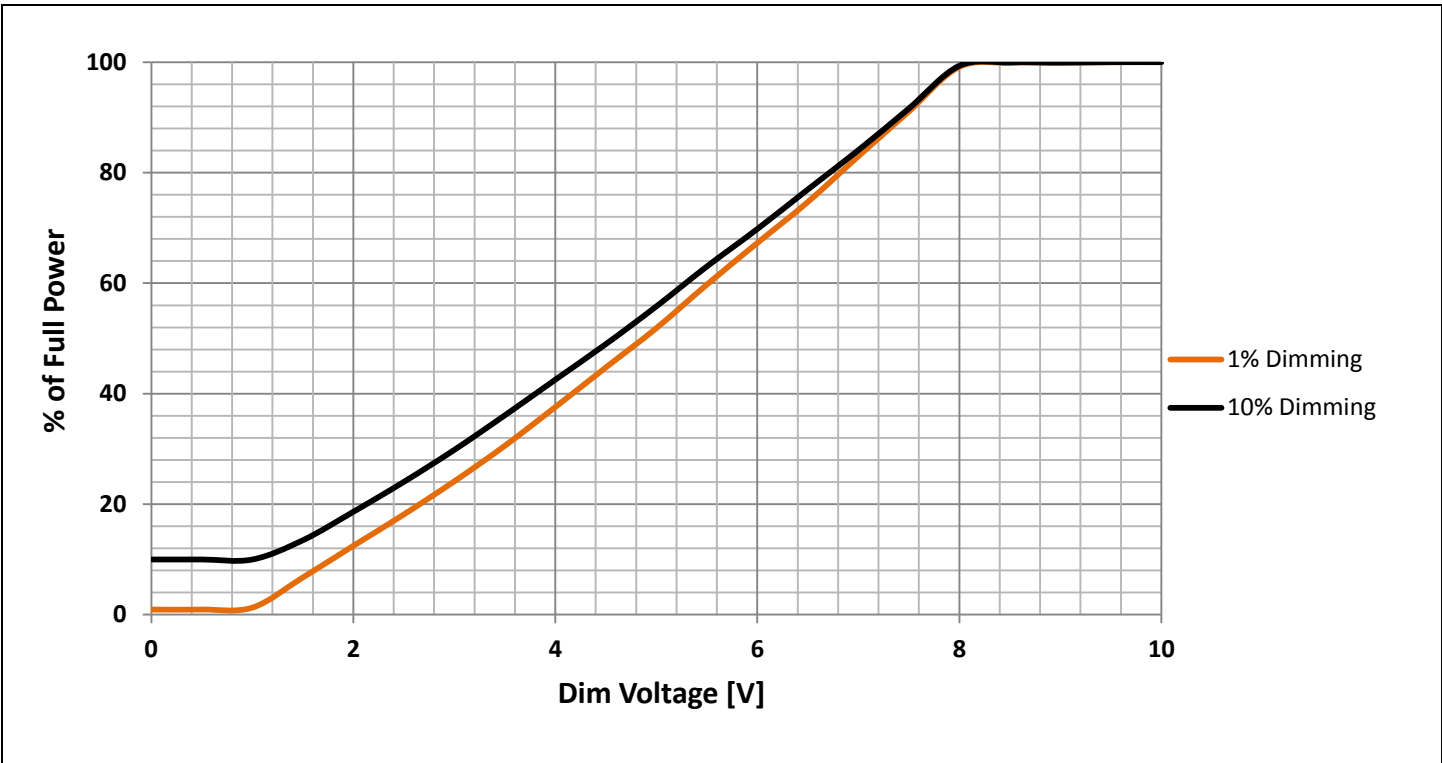

Efficiency @ 120V

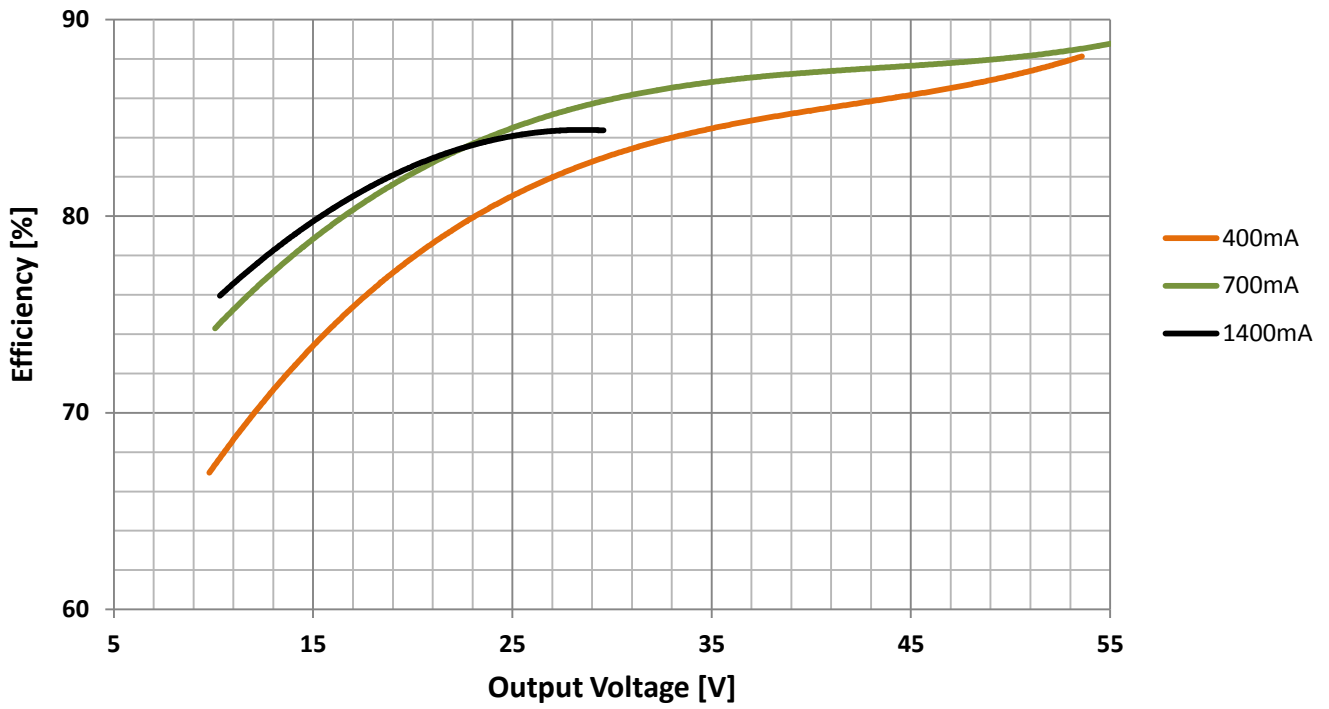

Efficiency @ 277V

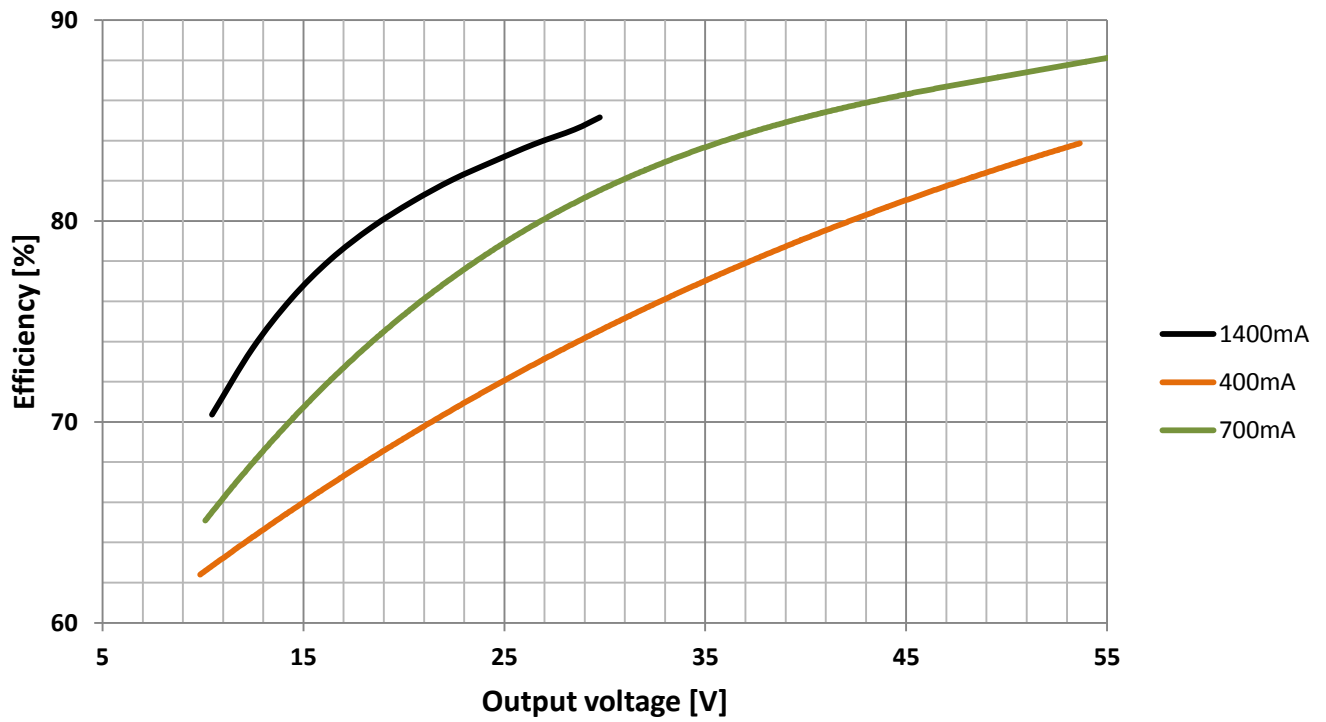

Power factor @ 120V

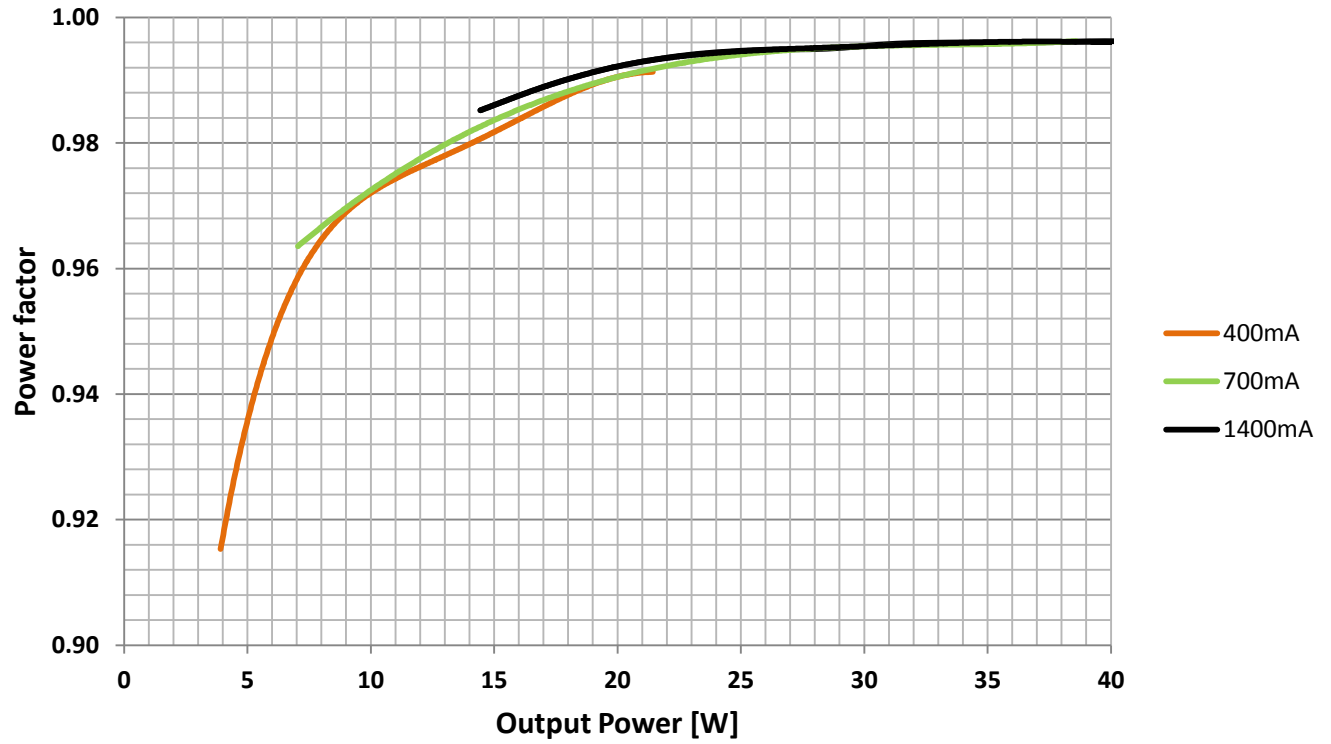

Power factor @ 277V

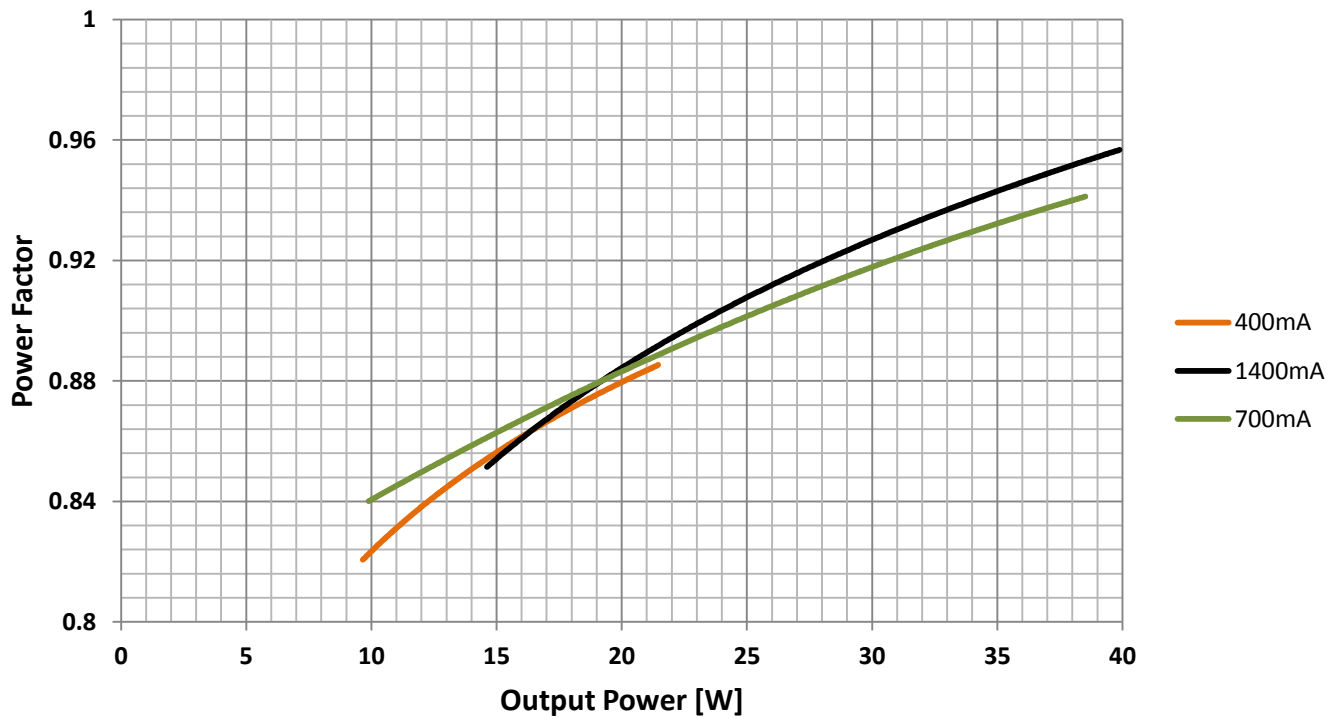

THD @ 120V

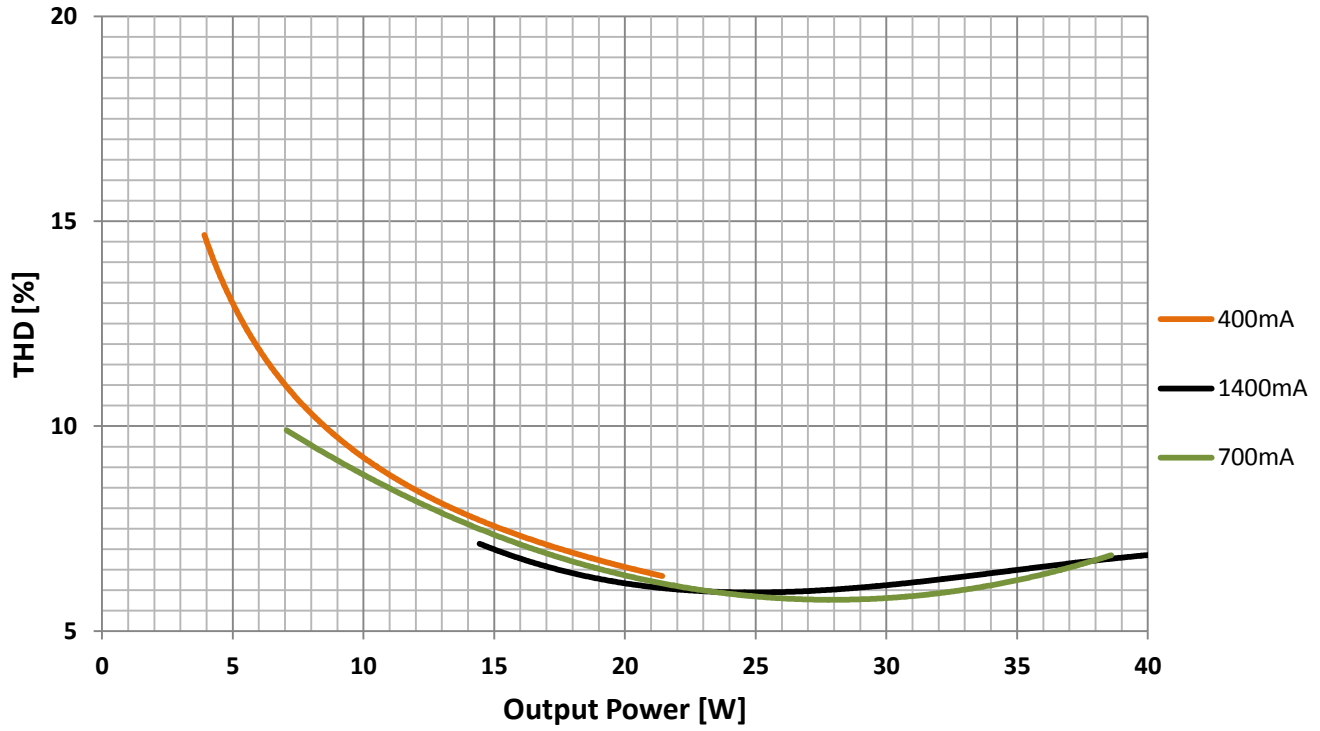

THD @ 277V

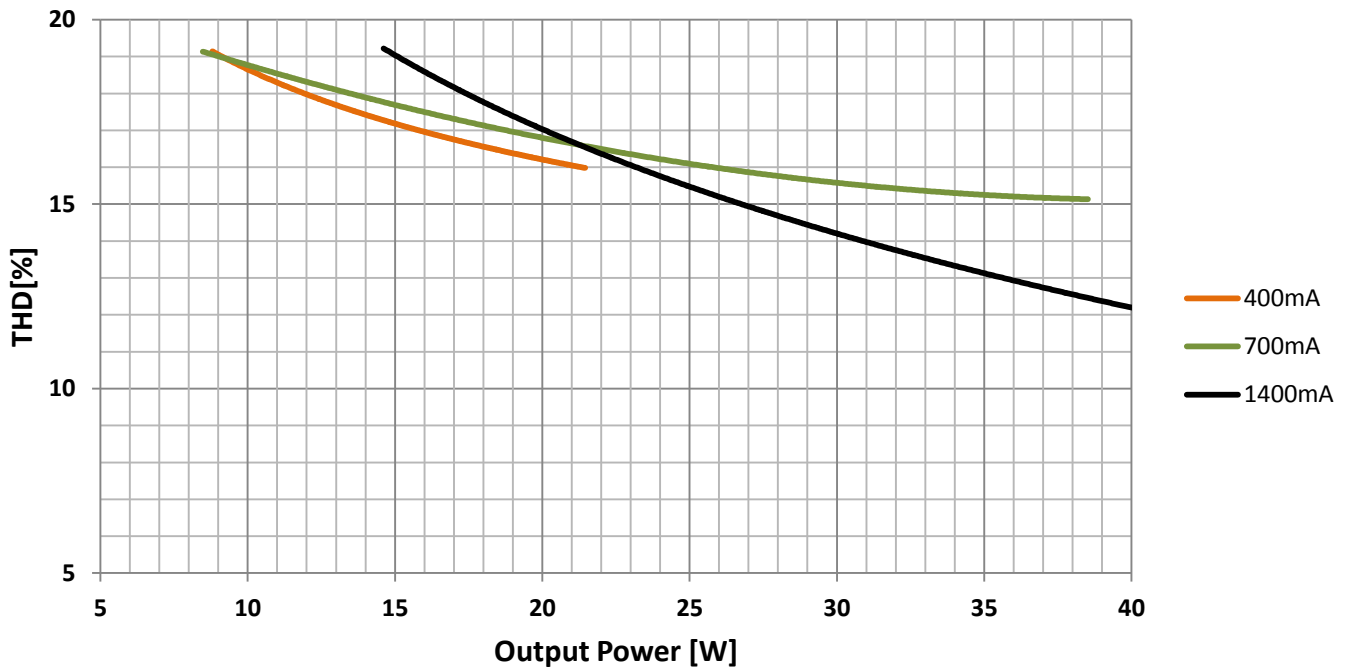

The LED thermal protection feature of the OT40W helps reduce the temperature of the LED module by reducing the output current in case of abnormal temperature conditions. To use this feature a third party NTC thermistor should be connected to the LED power supply as shown in the wiring diagram below.

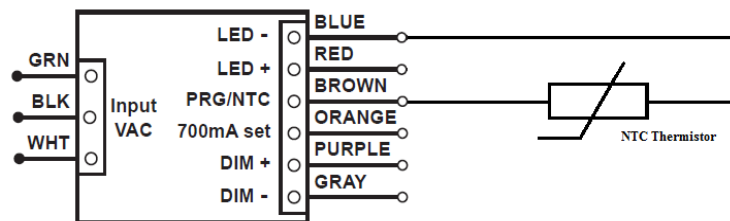

In the end application, care must be taken to place the NTC thermistor close to the hottest spot on the LED module. If LED thermal protection is not required the NTC port on the LED power supply connector can be left open. Vishay, EPCOS, Murata, Panasonic are some of the manufacturers of NTC thermistor. EPCOS part number for reference only **B57164K153J (15kΩ @ 25°C)**. Murata part number for reference only - **NCP03XH223J05RL (22kΩ @ 25°C)**

Note 4: Graphs for reference. The derating limits can be programmed using the OT Programmer (51645)

Derating start = 6.3kΩ; Derating end = 4.3kΩ; Min output level = 10%

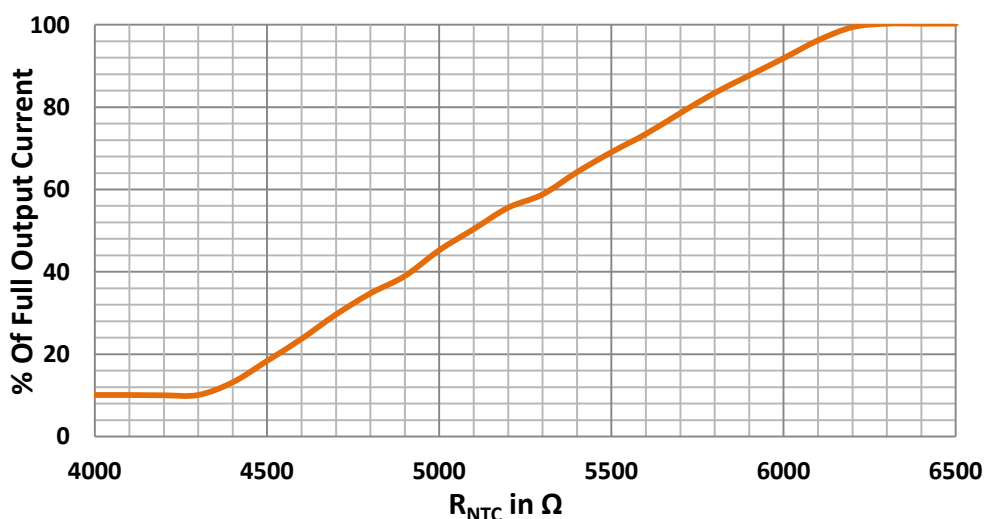

Derating start = 18kΩ; Derating end = 2kΩ; Min output level = 5%

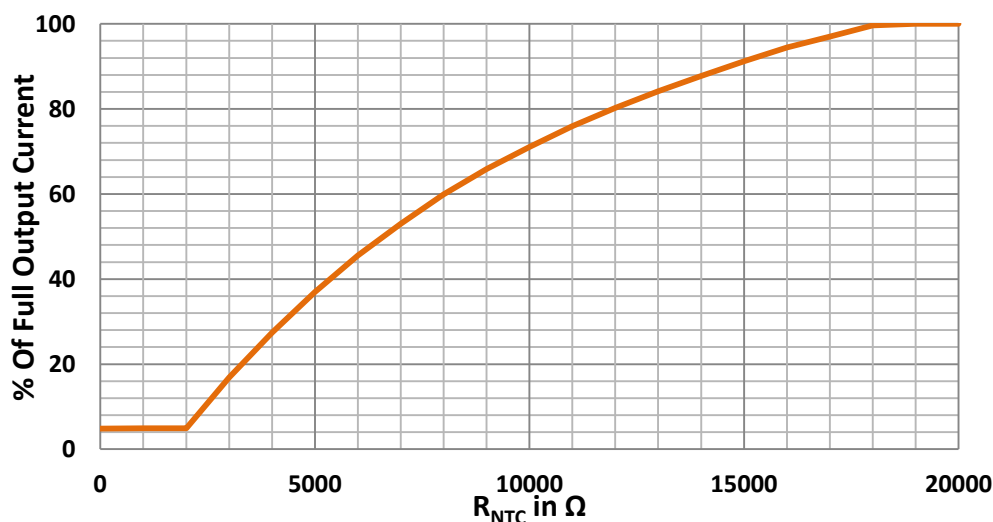

INRUSH CHARACTERISTICS

Vin (V)	Ipeak (A)	T (@ 50% of Ipeak)
120	9.1	5µs
277	20.8	5µs

DIMMER COMPATIBILITY

Manufacturer	Part no
Encelium EMS	EN-LCM-1R10V-GB2-BK EN-LCM-1R10V-GB2-BK/DR EN-ALC-1R10V-GB2-BK EN-ALC-1R10V-GB2-BK-DR
OSRAM	45561 - LC-SL3W-TVWBX/UNV
Leviton	IP710-DLX
Lutron	DVTV-XX
Wattstopper	ADF-120277
Synergy lighting Controls	ISD BC

Note: The absence of a dimmer from this chart does not necessarily imply incompatibility. Please reference the dimmer manufacturer's instructions for installation.

UL CONDITIONS OF ACCEPTABILITY (E320395)

Conditions of Acceptability – When installed in the end-product, consideration shall be given to the following:

- The LED driver has been evaluated using an electronic LED load resulting in a Class 2 output, for US only, with a rated output current of 400-1400 mA.
- The unit employs a R/C (OBJY2), Class B, isolation transformer (T1) on the main PWB. The need to repeat the temperature test shall be determined in end-use product. The unit has a rated TC point of 85°C.
- The unit was tested on a 20 A branch circuit. If used on a branch circuit greater than this, additional testing may be necessary.
- The PWB spacing for use in Damp locations has been evaluated to UL1310, Clause 24.5 per the Standard for Insulation Coordination Including Clearances and Creepage Distances for Electrical Equipment, UL 840, Table 9.1 for an Overvoltage Category II and Pollution Degree 1 (potted enclosure and under the PWB).
- The drivers are intended for built-in installations. Suitable Mechanical, Electrical and Fire Enclosure shall be determined in the end product application.
- The terminal blocks are intended for factory wiring only. The suitability of the input and output connection shall be determined in the end-use product.
- The products are intended for use in Dry and Damp locations. The use in other environmental locations shall be considered in the end product.
- The unit was not evaluated for supply grounding connection. Consideration for connecting the metal enclosure to a suitable grounding and bonding point shall be considered in the end product.

- These test conditions are for TL rating: This model was tested in a 40°C ambient. For Tref. values see Table Below. Determination to repeat the temperature test shall be made in end-use product. During the normal temperature test of the end product, the temperature at any point on the case is to be monitored and shall not exceed 90°C. When provided the tc in a circle can be a considered a reference hot spot on the case:

Product	Tref Max	Tref – measured @ 40C
OT40W/PRG1400C/UNV/XXXXX*	88°C	64°C

- *where XXXXX can be DIM or DIM-1 and may be followed by J

WARRANTY

OPTOTRONIC® products are covered by our LED Module, OPTOTRONIC Power Supply or Control Warranty. For additional details, refer to the latest version of the warranty (LED395) available at www.osram-americas.com/optotronic.

United States

OSRAM SYLVANIA

100 Endicott Street
Danvers, MA 01923
1-800-LIGHTBULB

Trade

Phone: 800-255-5042

Fax: 800-255-5043

National Accounts

Phone: 800-562-4671

Fax: 800-562-4674

OEM/Special Markets

Phone: 800-762-7191

Fax: 800-762-7192

Retail

Phone: 800-842-7010

Fax: 800-842-7011

SYLVANIA Lighting Services

Phone: 800-323-0572

Fax: 800-537-0784

Display/Optic

Phone: 888-677-2627

Fax: 855-543-1043

Canada

OSRAM SYLVANIA LTD.

2001 Drew Road
Mississauga, ON L5S 1S4
1-800-LIGHTBULB

Trade

Phone: 800-263-2852

Fax: 800-667-6772

OEM/Special Markets/Display/Optic

Phone: 800-265-2852

Fax: 800-667-6772

Retail

Phone: 800-720-2852

Fax: 800-667-6772

SYLVANIA Lighting Services

Phone: 800-663-4268

Fax: 866-239-1278

Mexico

OSRAM MEXICO

Tultitlan/Edo de Mexico

Phone: 011-52-55-58-99-18-50

ENCELIUM® Products

United States

Phone: 201-928-2400

Fax: 201-928-4028

Canada

Phone: 905-731-7678

Fax: 905-731-1401