

Light is OSRAM



OTi DALI 160/220-240/24 2CH DT6/8

24 V Multi-channel Constant Voltage LED driver
Dimmable range 0/0,1% - 100%

Benefits

Long lasting and high reliability.
DALI-2 DT6 and DT8 features in one driver.
DT6: 1 – 2 independent channels
DT8: TW applications.
Self-configuring channels.
High efficiency in slim form factor.
Patent-pending flicker-free dimming till 0,1%.

Applications

Hospitality, cove lighting, shops.
Suitable for indoor CLASS I and CLASS II luminaires.

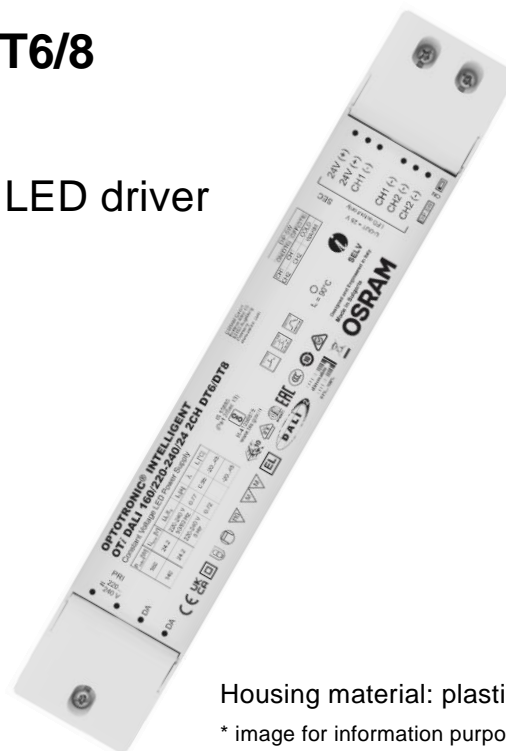

Housing material: plastic, white
* image for information purpose only

Approvals



L	300 mm	Total length
B	50 mm	Width
H	35 mm	Height

When not printed on product label, they are under evaluation.



Product Features

- DT6: 1 or 2 self-configuring DALI channels
- DT8 selectable by dip-switch or T4T
- Lamp Failure detection
- CLASS II independent housing
- Smart Power Supply
- SELV, Vout: 24,2 V
- t_a range -20...+45°C
- Overload/Over temperature and Short circuit protection
- Dimmable via DALI interface
- Very low min dimming level: 0,1%
- Mains voltage: 220–240 V_{ac} / 176–276 V_{dc}
- 50'000 h lifetime at max t_c*
- 5 years guarantee*
- IP20 independent housing (cable clamp)
- Output wire length up to 50 m
- Double button Touch DIM compatibility
- Emergency lighting compatibility

*10% cumulated failure, 24 h = 14 h ON, 10 h Standby

Electrical specification

	Item	Value	Unit	Remarks
INPUT	Nominal line voltage	220 – 240	V	
	Mains line frequency	0 / 50 / 60	Hz	
	AC voltage range	198 – 264	V	Max 350 V for 2 h. Auto switch off >280 V _{ac}
	DC voltage range	176 – 276	V	
	Nominal current	0.77	A	Typical @ Full load, 230 Vac, 50 Hz
	Total Harmonic Distortion (THD)	< 5	%	Full load, 230 V _{ac} , 50 Hz, see graphs
	Power factor λ	0,99		Full load, 230 V _{ac} , 50 Hz, see graphs
	Efficiency in full load	93	%	Typical, Full load, 230 V _{ac} , 50 Hz, see graphs
	Device power loss	11	W	Full load, 230 Vac, 50 Hz, Typical
	Networked stand-by power	<0,50	W	230 V _{ac} , 50 Hz. Typical 350 mW
	Protection class	II		
	Suitable for fixtures with prot. Class	I / II		
	Inrush current	57	A _{pk}	Full Load, 230 V _{ac} , Cold Start Duration = 280 μ s 50% / 50% I _{pk}
	Max. units per circuit breaker:			
	Max. ECG no. on circuit breaker 10 A (B)	4		B-Type is underusing thermal protection
	Max. ECG no. on circuit breaker 16 A (B)	7		
	Max. ECG no. on circuit breaker 25 A (B)	12		
	Max. ECG no. on circuit breaker 10 A (C)	8		C-Type is the preferable MCB choice
	Max. ECG no. on circuit breaker 16 A (C)	13		
	Max. ECG no. on circuit breaker 25 A (C)	20		
Max. ECG no. on circuit breaker 10 A (D)	9		D-Type is underusing short-circuit protection	
Max. ECG no. on circuit breaker 16 A (D)	14			
OUTPUT	Nominal voltage	24,2	V	
	Voltage accuracy	± 3	%	
	Voltage ripple	< 1	V _{pp}	@ 100 Hz, full load. Typical < 500 mV _{pp}
	Nominal output power	0 - 160	W	Power factor, harmonics and EMI guaranteed between 60 – 160 W
	Max output power in AC (at steady state)	160	W	Smart Power to manage up to Pout_max + 25%
	Max output power in DC (at steady state)	140	W	
	DC Output power (EL)	15	%	Pre-set value, adjustable via Tuner4Tronic
	Minimum load for channel autodetection	0,25	W	One single SEU is typically detected
	Galvanic isolation	SELV		
DIMMING	Dimming interface	DALI 2.0		Proper DALI diagnostics with a min. load of 9% (15 W) and dimming > 3%
	Dimming range	0,1 – 100	%	Dali dimming steps (0 – 254)
	Dimming method	PWM		
	TLA (Flicker and strobe effects)	P _{ST} < 1 SVM < 0,4	-	For every dimming condition (n.a. < 1%) Extended SVM metrics (10 kHz).
	Galvanic Isolation	Basic / Double		Basic DALI to Primary / Double DALI to Secondary
ENVIRONMENTAL	Ambient temperature range	-20...+45	°C	
	Max. temperature at Tc test point	90	°C	Measured on tc point indicated of the prod label, ta not exceeded
	Max. case temperature in fault condition	115	°C	
	Storage temperature range	-25...+85	°C	
	Permitted rel. humidity during operation	5 – 85	%	Not condensing
	Surge capability (L vs N)	1	kV	L/N acc to. EN 61547
	Environmental rating	Indoor		
	IP protection class	IP 20		
	Mains switching cycles	> 200000	cycles	@ ta = 25°C
	Expected ECG lifetime	50000	h	@ tc 90°C – 0,2% / 1000 h failure rate
		50000	h	@ tc 85°C – 0,1% / 1000 h failure rate

	Item	Value	Unit	Remarks
	No-load proof	Yes		Auto recovery
	Intended for no-load operation	No		
	Overheating protection	Yes		Auto recovery
	Overload protection	Yes		Auto recovery + Smart Power
	Short-circuit protection	Yes		Auto recovery
DIMENSIONS	Height	35	mm	
	Length	300	mm	Overall including fixing brackets
	Width	50	mm	
	Weight	380	g	
	Mounting holes interaxis	258	mm	
	Casing material	Plastic		White
	Type of connection	Screw terminals		0,5 – 2,5 mm ²
	Wire preparation length	6	mm	Input and output terminals

Protection

Over temperature, Overload, Short-circuit, Input overvoltage, Output overvoltage. Reversible.

Full load on one channel only is allowed.



DIP switch for DT6 or DT8 selection

- Input wires cross section: 0,5 – 2,5 mm²
- Output wires cross section 0,5 – 2,5 mm²
- Wire peeling length: input 6 mm, output 6 mm

LED wire length

The wire length from the ECG to the LED module can reach 50 m with verified EMI.

Below matrix shows the maximum LED load power according to cable length and section, at 25°C.

The proper wire section will ensure that the LED module input voltage is at least 23 V in the single-load worst case condition.

V _{out} 24,2V / nominal 160 W	Cable length [m]							
	AWG	mm ²	5	10	20	30	40	50
Cable section	17	1	156	78	39	26	19	16
	16	1.5	160	116	58	39	29	23
	14	2.5	160	160	96	64	48	39
	12	4	160	160	154	103	77	62
	10	6	160	160	160	155	116	93
	8	10	160	160	160	160	160	154

Values are indicative. Each connection may increase total voltage drop.

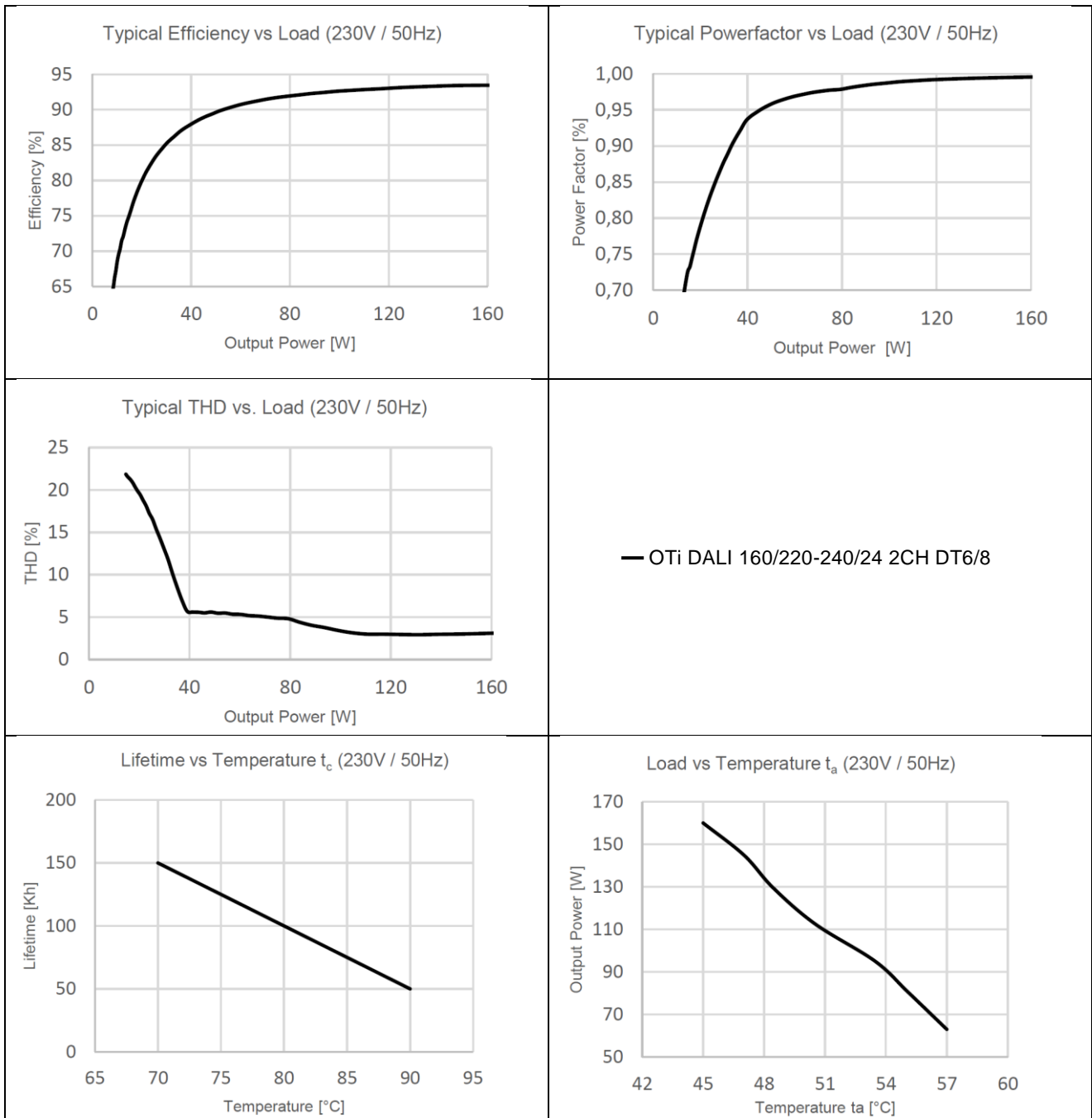

Channel addressing procedure (DT6)

AUTO ADDRESSING ON FIRST POWER UP

The ECG performs auto-channel-detection on first power up when set to DT6 operation (dip-switch: on).

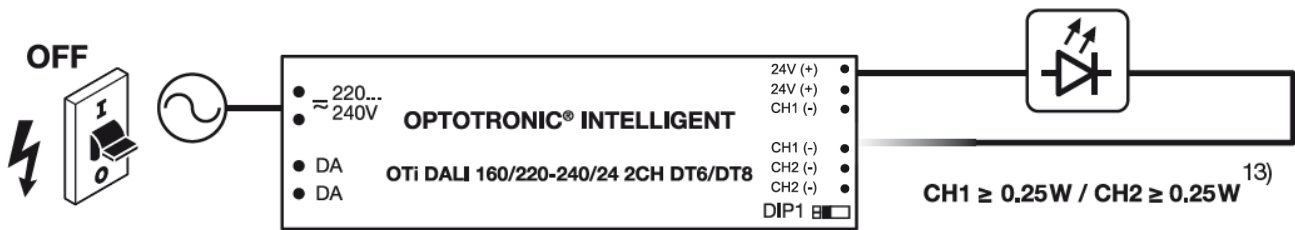

1. Connect the LED loads to the desired channels from 1 to 2.
2. Select "Device Type" to DT6 by the dip-switch. DIP-SW ON: DT6 (default) – DIP-SW OFF: DT8 TW
DT8 TW allows using CH1 as Cold and CH2 as Warm outputs

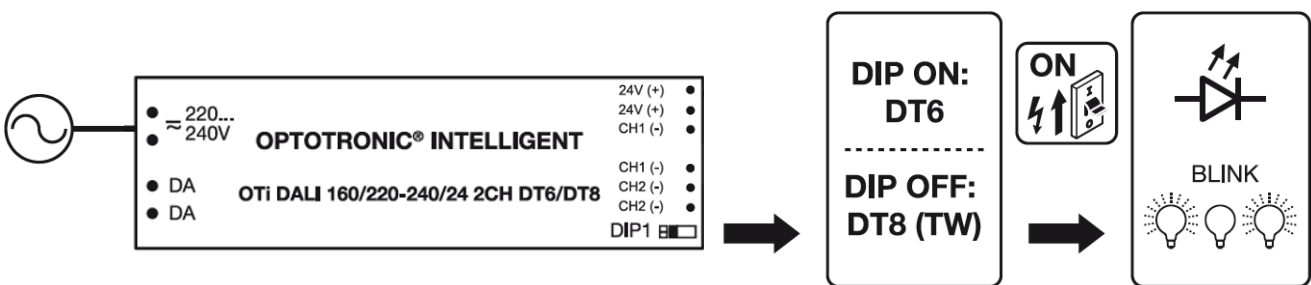

3. Connect the ECG to the mains: the LED loads start blinking.
4. After blinking stops, a DALI address has been assigned to each detected load.

Notes: There is no need to connect the only load to CH1. The output not connected to any load during the autodetect phase will stay off and won't get a DALI address.

ADDRESSING ERROR FIXING OR RESET

Every time the driver recognizes a dip-switch operation (from ON to OFF or vice-versa) it resets its channel configuration. In case DT6 addressing is newly required, the autodetection sequence can be restarted. In order to recognize the change, the driver must be active (powered, not stand-by) during or after each dip-switch operation.

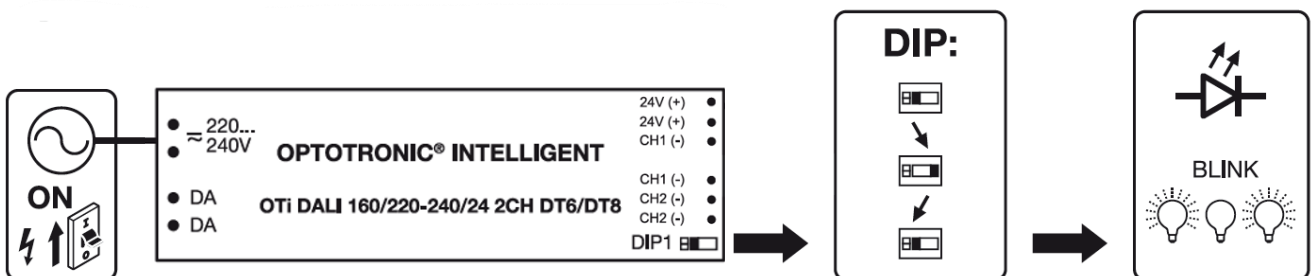

For instance, in order to reconfigure the driver for a new DT6 load configuration, after connecting or disconnecting new loads, move the dip-switch from ON to OFF, then from OFF to ON, during power-on or powering on after each operation.

Tunable White (TW) DALI-2 DT6 and DT8 modes

This driver can operate in TW operation under DALI-2 Device Type 6 or Device Type 8 mode.

DALI-2 DT6 needs two DALI addresses to operate in TW, one for warm white channel and one for cool white channel, while DALI-2 DT8 only needs one address for two channels.

DT6 mode allow LED load to be fully powered using 100% of its rated output. At fixed dimming condition, shifting from one CCT to the other will have impact on output luminous flux.

DT8 mode will prevent luminous flux alteration when moving through CCTs at the same dimming condition but **limited to this setting the device is able to support nominal power output (160 W) on each one of the two connected channels.**

Refer to below graphs to understand driver behavior on output power and luminous output of connected LED load.

Always make sure the DALI Master (if used) in the installation supports the designed DALI-2 “Device Type” mode.

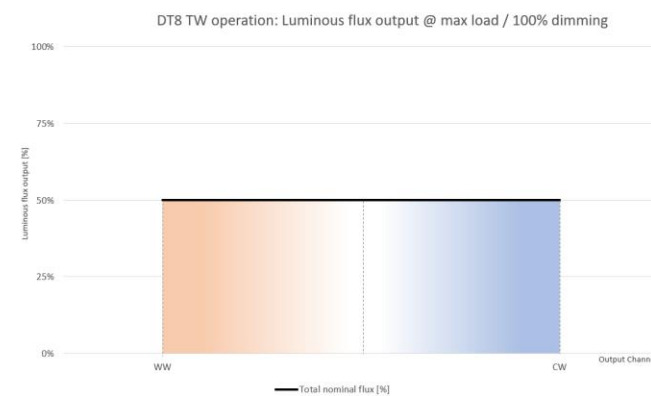
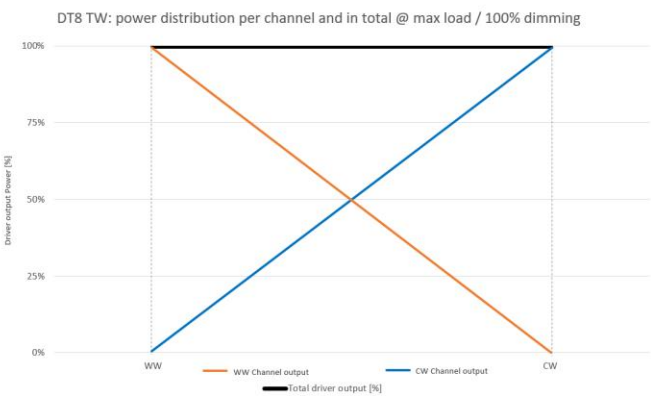
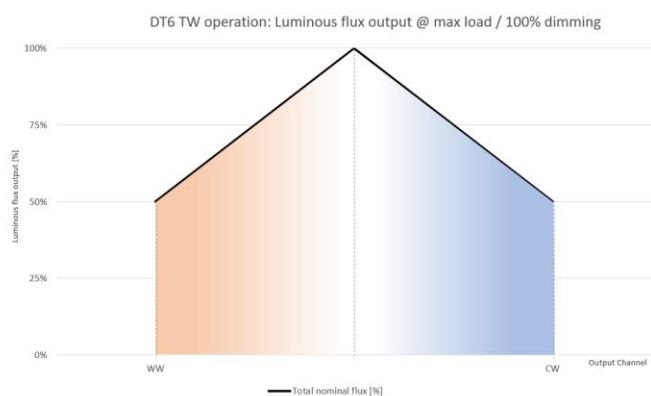
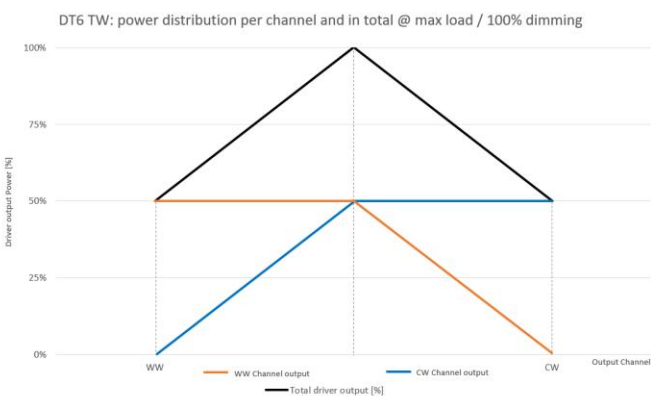

Driver programming

Connecting the drivers to OSRAM T4T tool (dip-switch override) allows the following programming options:

- Autodetected independent 1 or 2 channels DT6 – One address per channel (factory default).
- Preset fixed independent 1 or 2 channels DT6 – One address per channel.
- One DALI address, DT8 tunable white (TW).
- One DALI address, DT6 2 synchronized channels (SYNC).
- *Touch DIM, 1 channel (DT6 default with 1 channel, 1st push-button only).
- Touch DIM, 2 synchronized channels.
- *Touch DIM, 2 independent channels (DT6 default with 2 channels, 1st and 2nd push-button use).
- *Touch DIM TW (DT8 default, 1st push-button for brightness and 2nd push-button for color).
- Touch DIM, Dim to Warm.
- Corridor function, 2 synchronized channels (SYNC).

*: These are factory default configuration modes and do not require initial DALI programming by T4T, they are simply used and kept once the external buttons are recognized (5 s without DALI frames after last turn-on). All the other operating modes need specific programming by DALI connection and T4T application.

Single and double Touch DIM

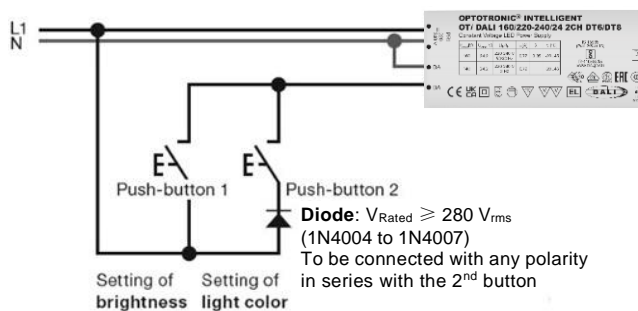

This driver supports single and double button Touch DIM operation. The 2nd button must be connected in parallel with the 1st by means of a diode.

As per factory default configuration, they are used:

- The 1st button to control the dimming level.
- The 2nd button to change the CCT mixing (DT8 TW) or the second channel level (DT6 independent).

Additional information

- The Touch DIM input voltage ranges from 10 Vac to 264 Vac and has single insulation from mains.
- DALI and Touch DIM must never be used at the same time: control is achieved either with DALI controller or with the Touch DIM function (self-recognized).
- Up to 20 ECGs can be controlled via direct push-button use. The number of push-buttons is limited by the sum of the overall cable length between switch(es) and the connected ECGs, which may not exceed 25 m. In case of longer distances, a small transformer or a DALI repeater must be used to get rid of line capacitance; this transformer cannot be used in case of rectified second button usage.
- For additional features, the button operation can be configured by means of the T4T application.

Touch DIM operation

The following item-list briefly describes the use of push-button for brightness control (1, 2 or SYNC CH):

- Switching the lamp on/off: Short Press (< 0,5 s).
- Dimming: Long Press (> 0,5 s); the dimming direction is changed with each press.
- Store reference value: double-click (press twice within 0,4 s) while lamp is *On* → Switch to *Mode 2*.
- Delete reference value: double-click while lamp status is *Off* → Switch to *Mode 1*.
- Long Press while lamp status off: the lamp is switched on at the minimum dimmer setting and faded up until the push-button is released.

In case of CCT Control (2nd button in TW mode), operation is similarly replicated but for white temperature:

- Short Press: sets the color temperature to mid of scale and the shift direction to warmer.
- Long Press: shifts color; the shifting direction is changed with each press.
- Double Press: sets *Mode 2* for color if lamp is on, or *Mode 1* if lamp is off (color blink confirmation).

Operating Modes

- Mode 1: the switch-on value is always the last brightness/CCT before the lighting was switched off.
- Mode 2: the switch-on value is the value stored by double clicking (default mode).

Re-synchronization

In case of many ECGs connected to the same Touch DIM buttons, there is a chance that an ECG will operate out of synchronism with the others (different on/off state, dimming level or CCT).

To have all of them back in synchronism, just apply a Long – Short – Long sequence, and in case apply a double-click afterwards to store a new common reference level. Short press on Push Button 2 re-synchronizes CCT.

Programming

Several parameters of Touch DIM can be programmed by T4T, for instance the Corridor Function, dimming limits, fading times, enable/disable functions, etc.

Light sensors

The Touch DIM system enables using Presence Sensors and/or Light Sensor directly connected to the DALI terminals. For such an application, please refer to OSRAM on-line documentation and catalogue.

Remarks

- **Product performances below minimal load condition:** the output power is still generated if the load is below the minimum output power of 60 W, without any safety risk, but performances regarding THD, EMI, etc. are not guaranteed. See typical operation window graph for details.
- **Output terminals:** The positive terminals are tied together.
- **Output short circuit protection:** short circuit current is limited without damaging the unit. The short circuit protection is self-restoring.
- **Output overload protection:** in case of overload (< 125%), the device automatically dims down the output to keep the power within 160 W and let the LED load warm-up. When the overload exceeds the 125% of maximum nominal output power, the LED load will blink to manifest a fault condition, till the short circuit limit (> 200%).
- **Input over voltage protection:** driver is capable of having input of max 350 V for 2 hours. To prevent damages to the unit, driver performs auto switch off when input voltage is >280 V_{ac}, therefore driver operation in this abnormal condition is not guaranteed. The over voltage protection is self-restoring.
- **Lamp failure detection:** minimum load that doesn't trigger open circuit detection is 15 W.
- **No load operation:** do not put a switch between ECG and load.
- Intended for use with LED modules.

The forward voltage of the LED light source shall be within the defined operating window of the control gear in all operating conditions including dimming if applicable.

- **Over temperature protection:** the driver is protected against temporary overheating, so it automatically dims down when t_c is exceeded, and eventually turns off. The protection is self-restoring.
- **Emergency lighting:** this LED power supply is suitable for emergency lighting fixtures acc. to EN 60598-2-22, with emergency output factor EOFI = 0,24 for OTi DALI 50 and EOFI = 0,15 for OTi DALI 80 (default values, programmable up to EOFI = 1 with P_{max} 12 W) and related duration time of 10 h at least. Function in emergency is ensured up to $t_a = 80^\circ\text{C}$ and $t_c = 96^\circ\text{C}$.

– **Ecodesign regulation information:**

Intended for use with LED modules. The forward voltage of the LED light source shall be within the defined operating window of the control gear in all operating conditions including dimming if applicable. Separate control gear and light sources must be disposed of at certified disposal companies in accordance with Directive 2012/19/EU (WEEE) in the EU and with Waste Electrical and Electronic Equipment (WEEE) Regulations 2013 in the UK. For this purpose, collection points for recycling centres and take-back systems (CRSO) are available from retailers or private disposal companies, which accept separate control gear and light sources free of charge. In this way, raw materials are conserved and materials are recycled.

Standards

EN 61347-1
 EN 61347-2-13
 EN 61547
 EN 61000-3-2
 EN 60598-2/22
 EN 62384
 EN 62386

Ordering information

Product name	EAN 10	EAN 40	Pieces / Box
OTi DALI 160/220-240/24 2CH DT6/8	4062172177948	4062172177948	20

OSRAM GmbH

Head Office:

Marcel-Breuer-Strasse 6
 80807 Munich, Germany
 Phone +49 89 6213-0
www.osram.com

