

PrevaLED® Flat AC DA

PL-FLAT-AC-DA-G3 1500-830 230V / EAN 4062172209380

PL-FLAT-AC-DA-G3 1500-840 230V / EAN 4062172209403

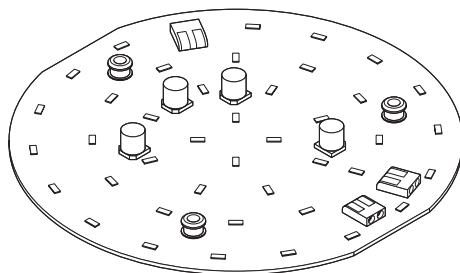

PL-FLAT-AC-DA-G3 2500-830 230V / EAN 4062172203388

PL-FLAT-AC-DA-G3 2500-840 230V / EAN 4062172203401

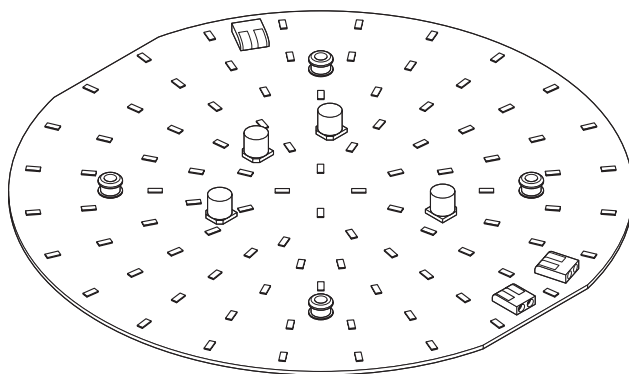

PL-FLAT-AC-DA-G3 1500-8X0 230V

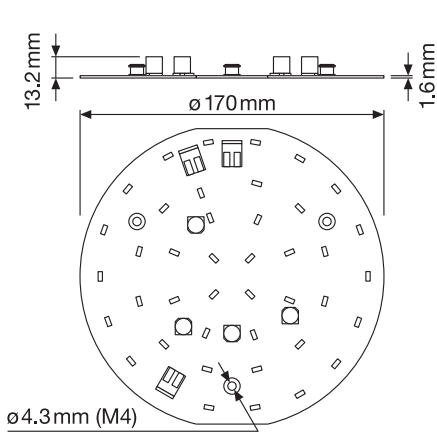

PL-FLTP 170 G2 / EAN 4052899969872

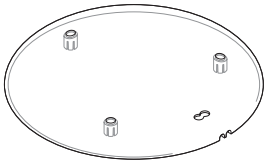

PL-FLAT-AC-DA-G3 2500-8X0 230V

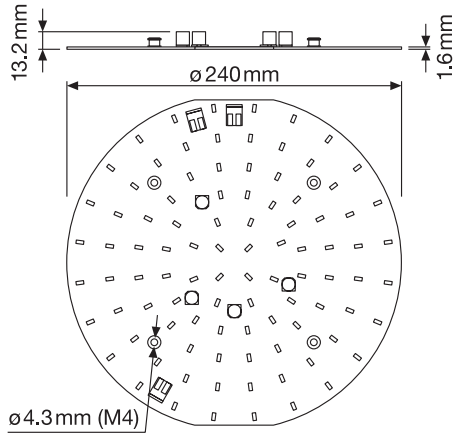

PL-FLTP 240 G2 / EAN 4052899969889

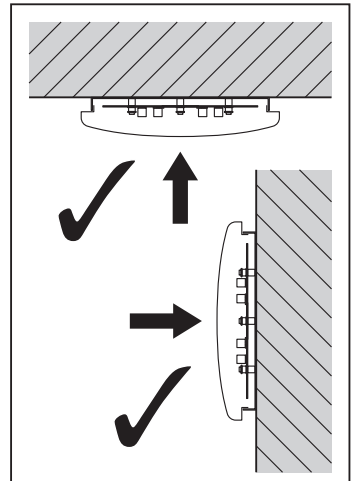
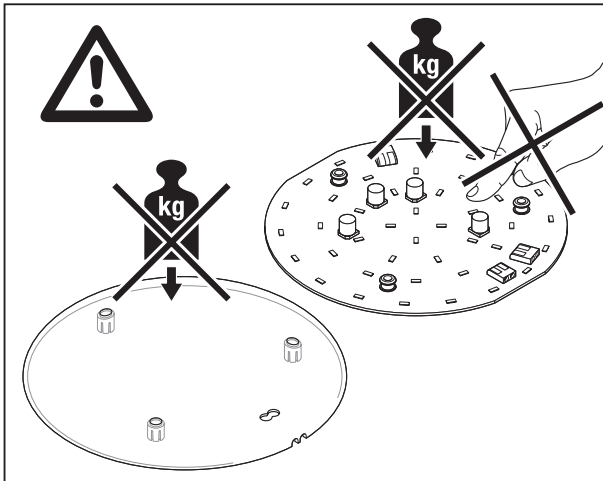
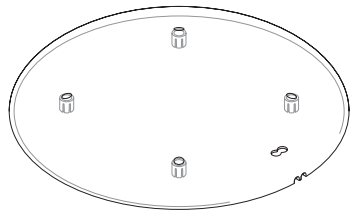

PL-FLAT-AC-DA-G3 1500-8X0 230V

1

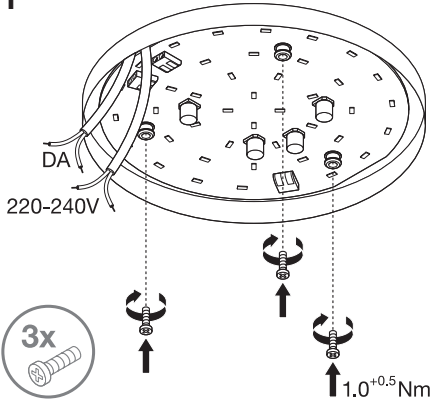

2

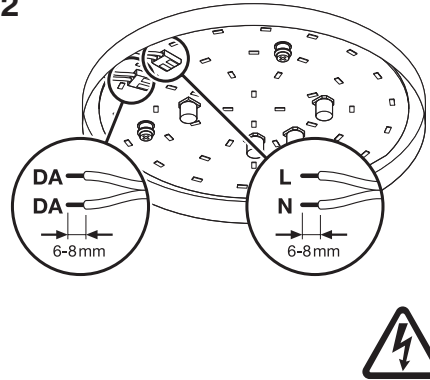

PL-FLAT-AC-DA-G3 2500-8X0 230V

1

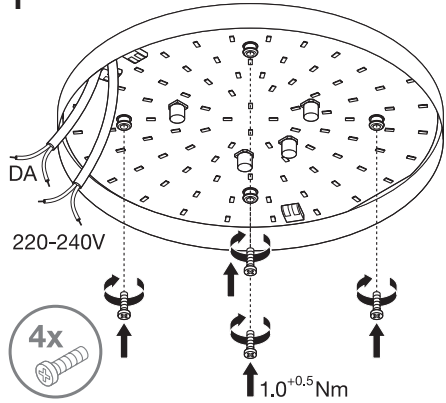

2

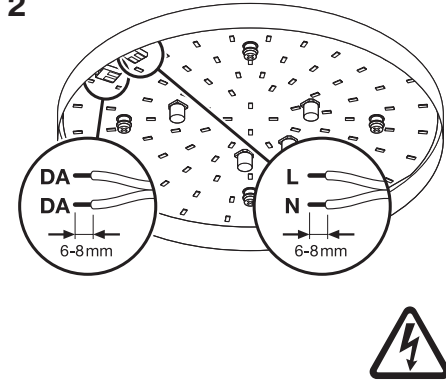

3

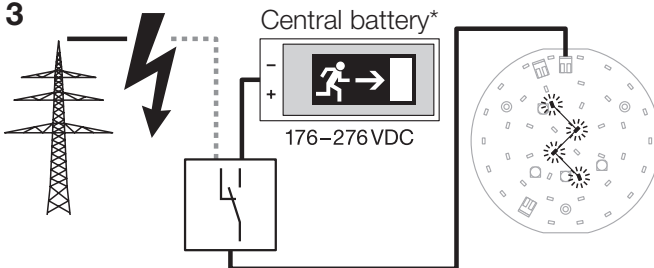

* ☐ Zentralbatterie ☐ Central battery
 ☐ Batterie centrale ☐ Batteria centralizzata
 ☐ Bateria central ☐ Bateria central ☐ Κεντρικό ουστημα μπαταρίας
 ☐ Centrale accu ☐ Centralmatade baterier ☐ Keskusaku ☐ Sentralisert batteri
 ☐ Centralt batteri ☐ Centrální baterie ☐ Центральная аккумуляторная батарея
 ☐ Központi akkumulátor ☐ Bateria centralna ☐ Centrálna batéria
 ☐ Srednja baterija ☐ Merkezi batarya ☐ Centralna baterija
 ☐ Batterie centrala ☐ Централна батерия
 ☐ Kohalik aku ☐ Pagrindinė baterija ☐ Centrālā baterija
 ☐ Centralna baterija ☐ Центральна батерея

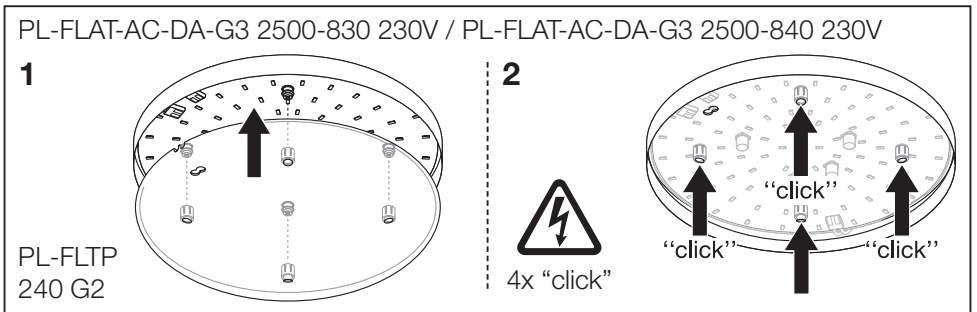
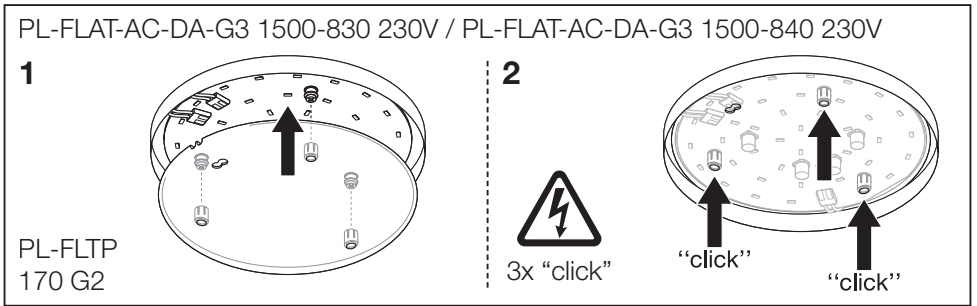
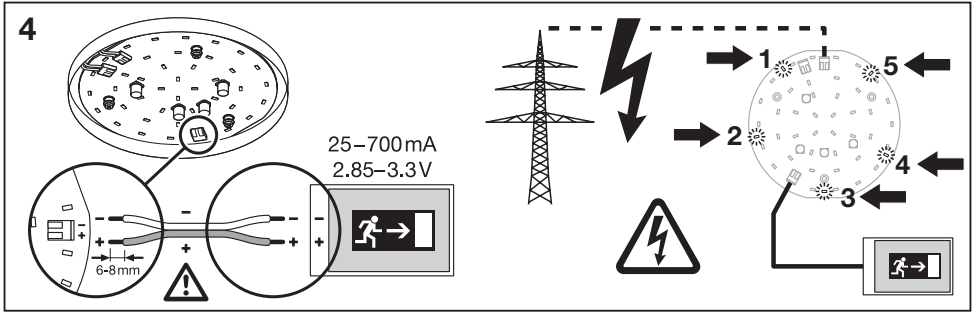

INVENTRONICS is a licensee of ams OSRAM. OSRAM is a trademark of ams OSRAM



220-240V~



C10449057
G15126009
22.08.23



Inventronics GmbH
Berliner Allee 65
86153 Augsburg
Germany
www.inventronicsglobal.com