

SFH 7776

(IR-LED + Proximity Sensor + Ambient Light Sensor)

Application Note

1. Introduction

The SFH 7776 combines a digital ambient light sensor and a proximity sensor (emitter + detector) within an ultra-small package. Additionally the sensor provides an I²C-bus interface and an interrupt pin to connect it to an e.g. microcontroller.

This application note describes the basic technical features and the components operation, allowing the user to achieve the full functionality and performance of the sensor. At the end a simple software code illustrates an example for the implementation of the SFH 7776 into a mobile phone environment.

Please note that this guide is only a brief introduction. For more detailed information and the latest products and updates please visit www.osram-os.com or contact your local sales office to get technical assistance during your design-in phase.

2. Applications

Typical application areas are mobile phones, PDAs, notebooks, cameras and other consumer products. Common tasks for the ambient light sensor are e.g. display brightness adjustments, whereas the proximity sensor is usually employed to detect objects and motions. This single component integrates several distinct functionalities and greatly simplifies the design-in process in consumer as well as industrial applications. The dark black look of the SFH 7776 makes it ideally suitable for implementation behind black cover glasses. Furthermore the SFH 7776 is capable of measuring the ambient light value outside the phone, even if the sensor is placed

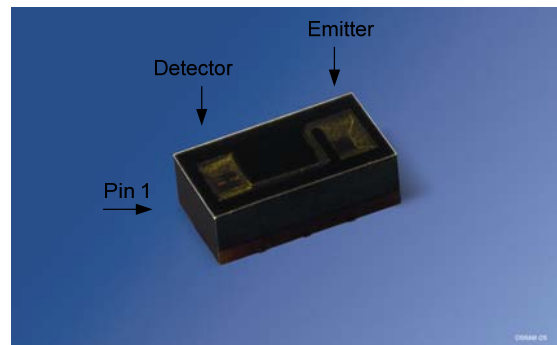

Fig. 1: Photography and orientation of the SFH 7776.

behind a dark cover glass with different spectral transmission characteristics.

The ultra-low power consumption makes the SFH 7776 especially suited for mobile applications, where conservation of battery power is a critical point.

3. The SFH 7776

The SFH 7776 (see Fig. 1) consists of an 850 nm infrared (IR) LED and an ultra-low power ASIC which performs the signal processing and provides the I²C-bus interface as well as an interrupt alert function. Additionally the ASIC contains two photodiodes: one for proximity and infra-red ambient light and another for visible ambient light sensing. The functional block diagram can be found in Fig. 2. The pinning of the device is stated in Tab. 1. The key features of the SFH 7776 include:

Proximity Sensor (PS)

- detection-range beyond 100 mm
- optimized for the integrated 850nm emitter
- ambient light suppression
- immunity to crosstalk
- fast access to PS signal

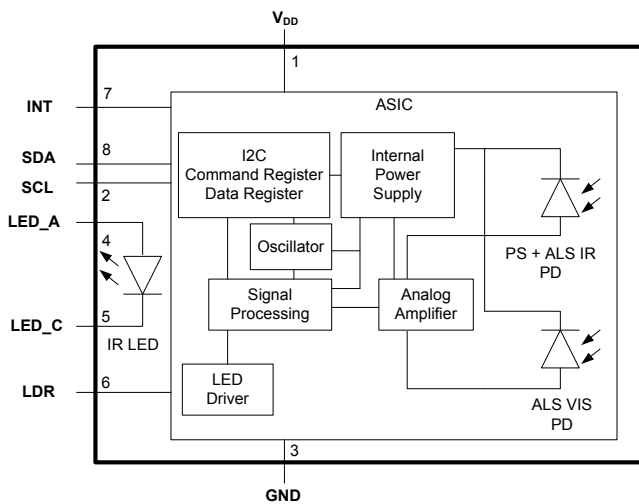

Fig. 2: SFH 7776 functional block diagram.

Pin No.	Pin Label	Description
1	V _{DD}	Digital Supply Voltage
2	SCL	I ² C-Bus Clock Line
3	GND	Ground
4	LED_A	IR-LED Anode
5	LED_C	IR-LED Cathode
6	LDR	LED Driver - connect to LED_C
7	INT	Interrupt Pin
8	SDA	I ² C-Bus Data Line

Tab. 1: Pin configuration of the SFH 7776

Ambient Light Sensor (ALS)

- 0.002 lx – 73 000 lx
- excellent linearity
- dual ALS concept (optimized to work behind dark cover glasses)
- lamp type detection

I²C-Bus Interface

- slave address 0x39
- 100kHz / 400kHz I²C bus speed
- programmable operation modes (*stand-by*, *free-running*)
- ultra low current consumption (< 1.5 µA) in *stand-by* mode
- configurable interrupt output with programmable threshold/hysteresis levels for PS and ALS
- persistence filter for interrupt

4. Ambient Light Sensor

The ambient light sensor is intended to provide ambient light measurement, e.g. to control and adjust the display brightness. To support this functionality the SFH 7776 provides a convenient user interface.

The ambient light sensor module consists of two photodiodes, labelled ALS_VIS (mainly sensitive in the visible range) and ALS_IR (sensitive in the infrared range) with different spectral characteristics.

The true illumination resp. lux can be calculated based on the information gathered by both diodes (see Eq. (1) on next page).

The two ambient light sensors deliver output values in the range from 0 to 65535 (16 bit). Low output values correspond to a low illumination of the sensor, while high values indicate high illumination. The range of the ambient light sensor sensitivity can be set by the user and covers more than 4 ½ decades in each setting. Two threshold levels for the ambient light sensor (ALS_VIS) can be set via the I²C-bus, a lower and an upper threshold. In the case of exceeding this specified range, an interrupt signal can be generated, allowing e.g. the microcontroller to act accordingly (see Sec. 8.3 for the relevant registers and settings).

4.1 Spectral Sensitivity of the ALS

The spectral sensitivities of the ALS_VIS and ALS_IR sensor of the SFH 7776 (see Fig. 3) are designed to provide ample information about the light source and allows subsequently with a simple set of equations to calculate the true ALS value (illumination) based on this data. This is especially important as in mobile applications the SFH 7776 is often hidden behind a dark, IR-transmissive cover glass, which makes it difficult for a single channel ALS to calculate the (true) ALS value.

The following Eqs. are recommended to be applied to calculate the true ALS lux-value out of the ALS_VIS and ALS_IR data. The Eqs. are valid for the illumination in front of the sensor (e.g. no cover glass or glasses with flat transmission characteristics from visible into the IR region). For applications with a (dark) cover glass please refer to Sec. 10.1.

```

IF (ALS_IR / ALS_VIS) < 0.109
  LUX = (1.534 * ALS_VIS / GAIN_VIS
        - 3.759 * ALS_IR / GAIN_IR)

ELSE IF (ALS_IR / ALS_VIS) < 0.429
  LUX = (1.339 * ALS_VIS / GAIN_VIS
        - 1.972 * ALS_IR / GAIN_IR)

ELSE IF (ALS_IR/ALS_VIS) < (0.95 * 1.45)
  LUX = (0.701 * ALS_VIS / GAIN_VIS
        - 0.483 * ALS_IR / GAIN_IR)

ELSE IF (ALS_IR/ALS_VIS) < (1.5 * 1.45)
  LUX = (2 * 0.701 * ALS_VIS / GAIN_VIS
        - 1.18 * 0.483 * ALS_IR / GAIN_IR)

ELSE IF (ALS_IR/ALS_VIS) < (2.5 * 1.45)
  LUX = (4 * 0.701 * ALS_VIS / GAIN_VIS
        - 1.33 * 0.483 * ALS_IR / GAIN_IR)

Else
  LUX = 8 * 0.701 * ALS_VIS / GAIN_VIS

LUX = LUX * 100 ms / T_INT_ALS

```

Eq. (1)

With T_{INT_ALS} representing the ALS integration time (t_{INT_ALS}) according to register 0x41 setting and $GAIN_VIS = GAIN_IR$ according to setting in reg. 0x42. If a cover glass is used an additional gain factor needs to be added to compensate for any Fresnel loss (attenuation) due to the glass.

Fig. 4 compares the calculated illumination (lux) values and relates them to the human eye sensitivity (V_{λ} , $V(\lambda)$), assuming

the same illuminance value. The values are normalized and compared to the perception of the human eye for different light sources. The typical deviation is well within $\pm 20\%$ if above Eqs. are implemented.

4.2 Directivity of the ALS

The angular directivity of the SFH 7776 is presented in Fig. 5. The typ. half-angle is around $\pm 25^\circ$. This is an important point for considering the design of potential cover glass apertures (please refer to Sec. 10.5 for more details).

4.3 Sensitivity Range of the ALS

The sensitivity range of the ALS can be programmed by the user via the MODE_CONTROL (0x41) and ALS_PS_CONTROL register (0x42). The illumination range scales by the GAIN and ALS integration time (t_{INT_ALS}) settings. Fig. 6 presents the ALS_VIS signal vs. the illumination range. The graph represents the highest and lowest sensitivity range setting (valid for e.g. white LEDs or fluorescence lamps). Please refer to Tab. 2 for a listing of all the possible ALS ranges.

5. Proximity Sensor

The proximity sensor delivers output values within the range from 0 up to 4095 (12 bit, linear). Low output values correspond to low irradiance of the sensor, while high values indicate high irradiance. Threshold levels with or without a hysteresis for an interrupt alert can be set via the I²C-bus (see Sec. 8.3 for the relevant registers and settings). The integrated proximity measurement operates at 850 nm.

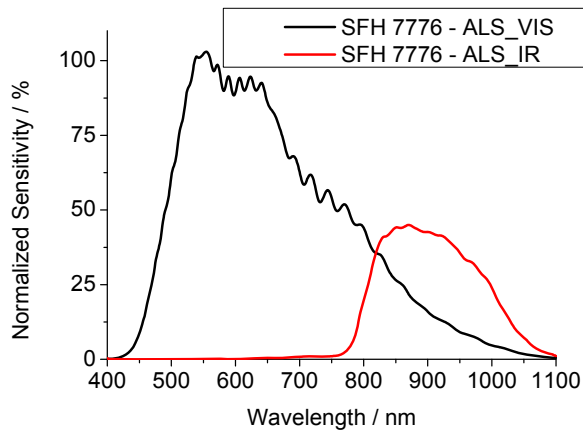

Fig. 3: Spectral sensitivity of the two ALS sensors of the SFH 7776 (ALS_VIS and ALS_IR have equal gain setting).

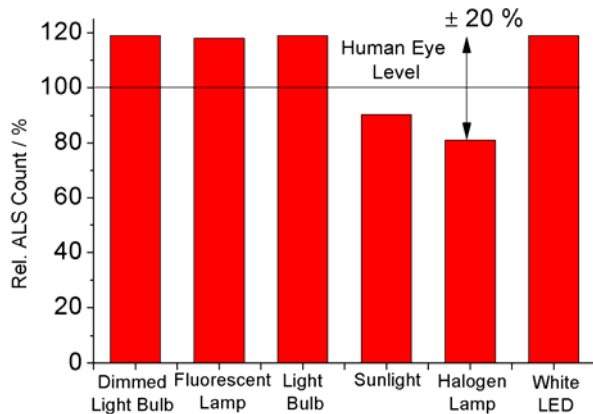

Fig. 4: Typ. ambient light sensor accuracy vs. different light sources (after applying Eqs (1)).

Illumination Range	GAIN ALS_VIS	t _{INT_ALS}
1.10lx ... 73321lx	1	100 ms
0.57lx ... 36660lx	2	100 ms
0.017lx ... 1146lx	64	100 ms
0.0086lx ... 572lx	128	100 ms
0.28lx ... 18329lx	1	400 ms
0.14lx ... 9164lx	2	400 ms
0.0044lx ... 286lx	64	400 ms
0.0022lx ... 143lx	128	400 ms

Tab. 2: ALS sensitivity vs. GAIN ALS_VIS resp. t_{INT_ALS} settings (e.g. white LED or fluorescent lamp).

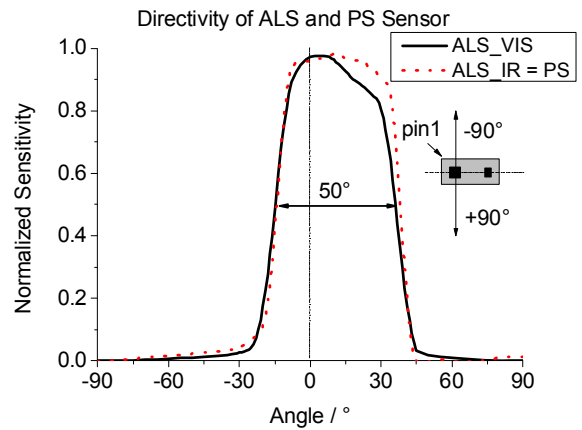

Fig. 5: Directional characteristics of the ambient light (ALS) and proximity (PS) sensor.

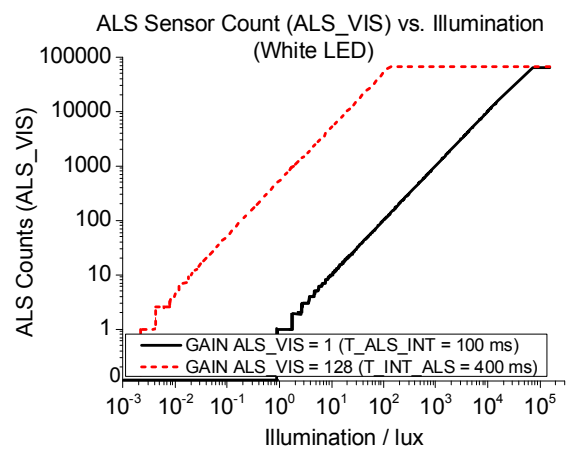

Fig. 6: Ambient light sensor count (ALS_VIS) vs. illumination (different gain and integration time settings). The curves represent the maximum resp. the minimum sensitivity setting.

5.1 Functionality of the PS

The SFH 7776 uses a single 200 μs LED pulse. Fig. 7 illustrates the signal during a complete measurement cycle. After the measurement the proximity data are immediately available and interrupt registers are updated. Measurement repetition time in the free running mode can be selected to be 10ms, 50 ms, 100 ms or 400 ms (register 0x41). Two options are available: normal mode with single IR-LED pulse and two-

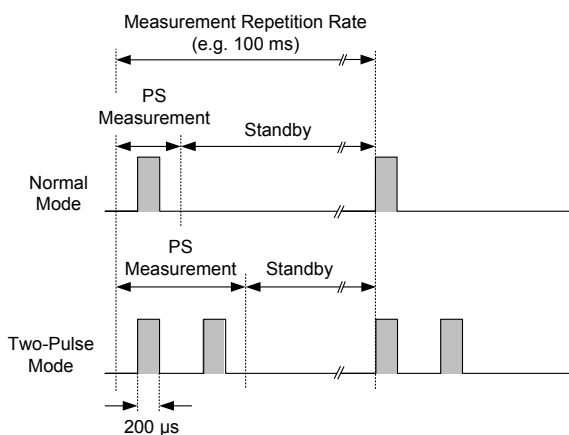

Fig. 7: LED drive current and timing during one proximity measurement cycle (two options are possible: normal and two-pulse mode).

pulse mode with two consecutive pulses where the persistence number increases twice as fast (see Sec. 5.5). PS data, PS related interrupt and persistence are updated after every pulse.

5.2 Proximity Count and Detection Range

The maximum detection range depends – among others – on target properties like size and reflectivity and on the IR-LED pulse current. To reach a maximum detection range the recommended value for the LED drive current is 200 mA.

Fig. 8 to 10 present the proximity values vs. target distance for a 100 x 100 mm² Kodak White (90 %), Kodak Grey (18 %) and Opteka Black (~ 4 %) target (no cover glass) vs. different IR-LED currents. As indicated, the typ. maximum detection range for the SFH 7776 is in the range of beyond 100 mm (by using 200 mA LED current (Kodak White and setting a threshold level for the interrupt alert at 7 counts). As a general rule it is recommended for a robust design to set the threshold level at least up to around 7 counts above any offset level (the typ. internal offset level of the SFH 7776 is below 1 count).

Despite its crosstalk-free range **the SFH 7776 features zero-distance detection.**

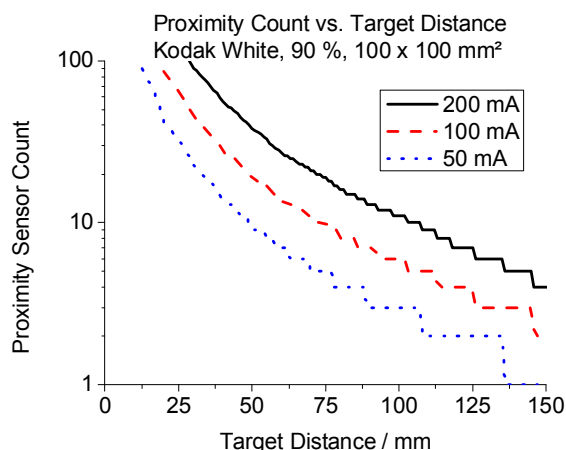

Fig. 8: Proximity sensor signal vs. target distance and LED drive current (reflector: Kodak White, 90 %, 100 x 100 mm²).

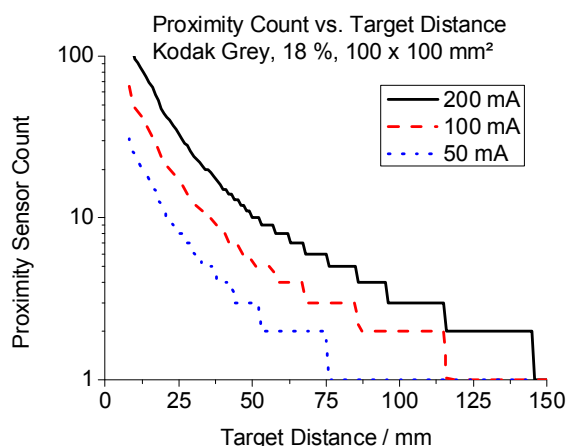

Fig. 9: Proximity sensor signal vs. target distance and LED drive current (reflector: Kodak Grey, 18 %, 100 x 100 mm²).

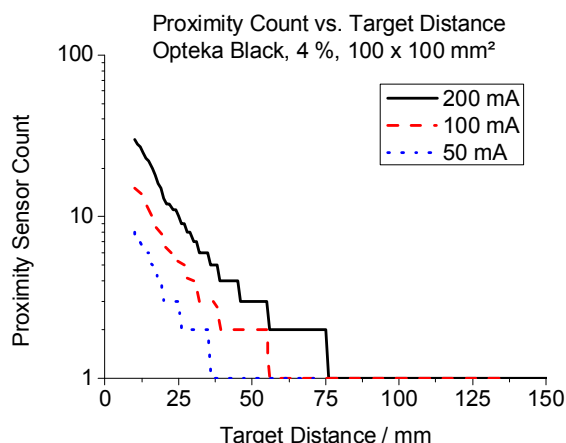

Fig. 10: Proximity sensor signal vs. target distance and LED drive current (reflector: Opteka Black, 4 %, 100 x 100 mm²).

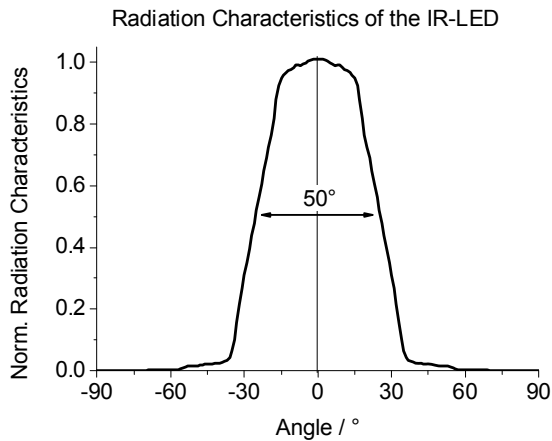

Fig. 11: Radiation characteristics of the proximity sensor LED.

E.g. touching the sensor with a human finger produces enough PS counts (typ. hundreds of counts above any typical threshold setting at 200 mA IR-LED current), making the sensor capable of handling touch events (see also Sec. 10.4).

5.3 Radiation Characteristics of the PS-LED

Fig. 11 presents the radiation characteristics of the IR-LED. As indicated, the typ. FWHM is around 50°. This characteristic influences the design of the cover glass aperture. Please refer to Sec. 10.5 for a more detailed discussion on the cover glass aperture design.

The angular sensitivity of the proximity sensor photodiode (detector) is similar compared to the emitter's radiation characteristics (see Fig. 5).

Due to its flat-top radiation characteristics a more homogeneous irradiance of any target is achieved compared to conventional (lensed) products.

5.4 Crosstalk

In general, most proximity sensors are hidden behind a cover glass. However, the cover glass causes reflections which might

make it difficult to operate with a fixed threshold level as the crosstalk may vary due to mechanical variations for different customer assemblies. A common and proven solution is the use of an external separator to avoid the reflections from the cover glass. However, such a separator causes additional design-in effort.

Due to its design the SFH 7776 is crosstalk-insensitive for a range of typical applications. Fig. 12 presents this range as a function of cover glass thickness vs. the spacing between the bottom of the cover glass and the top of the SFH 7776 (= airgap). Typical applications where the SFH 7776 works without an external separator are e.g. 0.9 mm of a (dark) cover glass thickness and an airgap of up to 0.5 mm. Note that the crosstalk-free range depends on the actual design of the cover glass aperture. To utilize the full potential of the SFH 7776 it is **recommended to use a two-hole circular aperture design at the bottom side of the cover glass** (please refer to Sec. 10.5 for more details). The recommended aperture diameter is e.g. $\varnothing \leq 1.8$ mm for a typical airgap of < 0.5 mm. Beyond the as "crosstalk-free"-indicated area the crosstalk level might rise above 1 count (strongly dependent on the scattering properties of the ink). Typically the airgap can be extended up to 0.8 mm resulting only in a slight increase in crosstalk counts. In any case it is recommended to verify the actual design. Please note that beyond the proposed "crosstalk-free"-range the sensor works as well, but might experience a certain offset-level, dependent, among other issues, on the type of glass and mechanical variations. Please note that coloured (dark) cover glasses might cause some crosstalk-offset, depending on the type/quality of the cover glass and the surrounding IR-absorbing dark material. Experimental verification of the behaviour is mandatory here. In case an offset is present, it is recommended to set the threshold at least around 7 counts above any crosstalk offset.

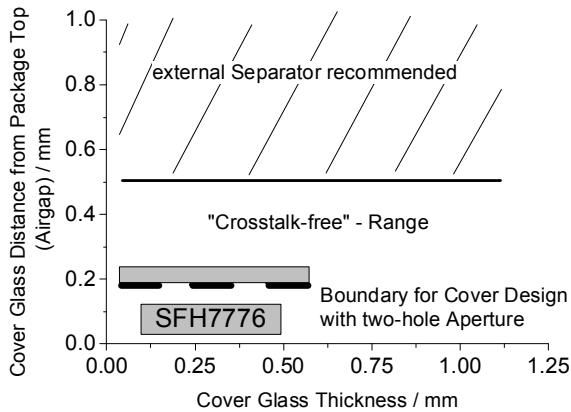

Fig. 12: Crosstalk-free range: Cover glass thickness vs. airgap. The device is "crosstalk-free" for e.g. 1.0 mm cover glass and an airgap of 0.5 mm. To achieve optimized performance a two-hole aperture design is recommended (see Fig. 13).

Note that the above range is based on a crosstalk level of ≤ 1 count at pure glass. It is important to mention that the actual crosstalk level depends also on the properties of the dark ink. Typically the device can be operated up to 0.8 mm airgap with negligible crosstalk, i.e. ≤ 2 counts (depending on the quality of the dark ink).

5.5 PS Persistence Feature

The SFH 7776 features a persistence option. This helps to suppress any potential flickering of the interrupt signal in case an object / signal jitters between the two thresholds (hysteresis), i.e. this functionality smoothens out the transition between interrupt on and off.

The implemented persistence function can be activated in reg. (0x43). Only if n-consecutive measurements fulfil the threshold condition the interrupt is initiated resp. turned off (n can be set to be between 1 and 15). Please note that the two-pulse operation (accessible via MODE_CONTROL register (0x41)) in combination with persistence allows two times faster update of the interrupt functionality instead of normal (single pulse) mode operation.

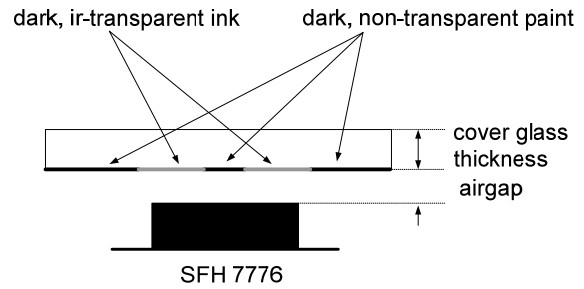

Fig. 13: Two-hole aperture design for minimum crosstalk level.

6. Power Consumption

The following equations give an idea on the total power consumption of the SFH 7776 during standard operation at 2.5 V.

By operating the PS in the free-running mode, the current consumption in normal operation mode (single PS pulse mode) can be approximated by the following Eq. (depending on the LED current I_{LED} and the measurement repetition time t_{rep_PS}):

$$I_{AVG_PS} \approx 200\mu s \cdot \frac{(I_{LED} + 6.5 mA)}{t_{rep_PS}} + 50\mu A \quad \text{Eq. (2)}$$

The current consumption during operation of the ALS depends on the ALS integration time t_{int_ALS} as well as the ALS repetition time t_{rep_ALS} and can be approximated by:

$$I_{AVG_ALS} \approx 60 \mu A + 130 \mu A \cdot \frac{t_{int_ALS}}{t_{rep_ALS}} \quad \text{Eq. (3)}$$

Example for total PS current consumption ($I_{LED} = 100 mA$ and $t_{rep_PS} = 100 ms$):
 $\Rightarrow I_{AVG_PS} \approx 263 \mu A$ (incl. IR-LED current)

Example for total ALS current consumption ($t_{int_ALS} = 100 ms$ and $t_{rep_ALS} = 400 ms$):
 $\Rightarrow I_{AVG_ALS} \approx 92 \mu A$

This compares to a stand-by current consumption of less than $1.5 \mu A$ (typ. $0.8 \mu A$).

I2C Bus Address of SFH 7776
0x39

Tab. 3: The I²C-bus address of the SFH 7776.

7. Operating Modes

The SFH 7776 can be operated in different modes:

free-running (ALS and / or PS running alone or simultaneously): The sensor continuously measures and writes the results into the relevant registers, ready to be read via the I²C-bus interface. Optionally the interrupt alert function with the user-defined threshold levels (PS and/or ALS) will be executed if such an event takes place.

stand-by: The initial state after power-up. The SFH 7776 is in low power mode ($I_{DD} < 1.5 \mu A$), no operations are carried out, but the device is ready to respond to I²C-bus commands.

additionally, there is the off-state:

off: The SFH 7776 is inactive, supply current is typ. below 0.8 μA . The SDA, SCL and INT pins are in Z-state (high impedance). All register entries are reset to their default values.

The initial start-up time is 2 ms. The typ. voltage V_{DD} to switch the SFH 7776 into the off-state is $< 2.0 V$. To power the SFH 7776 into the stand-by mode typ. 2.0 V are required.

8. I²C – Bus Communication

The **I²C-bus address** of the SFH 7776 is **0x39**.

8.1 I²C - Bus Environment

The SFH 7776 is a digital ambient light and proximity sensor. The communication is performed via a 2-wire I²C bus interface, so

Mode	Bit Rate
Standard mode (Sm)	≤ 100 kbit/s
Fast mode (Fm)	≤ 400 kbit/s

Tab. 4: The I²C-bus protocol speed mode compatibility of the SFH 7776.

the device can be integrated into a typical multi-master / multi-slave I²C bus environment. A typical I²C bus network consists of a master and different I²C bus slave devices. For a more detailed discussion on the topic of I²C-bus please refer to [2].

The built-in I²C-bus interface is compatible with all common I²C-bus modes (see Tab. 4). The logic voltage (V_{IO}) of the SFH 7776 ranges from 1.65 V – 3.6 V (according to I²C-bus specification [2]).

8.2 I²C - Bus Communication

By embedding the SFH 7776 in an I²C-bus network and after applying $V_{DD} = 2.5 V$, the communication can start as follows (Fig. 14 illustrates this I²C-bus conversation):

1. Activation of the ALS and PS:

The default mode of the sensor is STAND-BY and the SFH 7776 needs to be activated by the master (e.g. microcontroller).

Each I²C bus communication begins with a start command “S” of the Master (SDA line is changing from “1” to “0” during SCL line stays “1”) followed by the address of the slave (0x39). After the 7bit slave address the read (1) or write (0) R/W bit of the master will follow. The R/W bit controls the communication direction between the master and the addressed slave. The slave is responding to a proper communication with an acknowledge command. Acknowledge “A” (or not acknowledge “NA”) is performed from the receiver by pulling the SDA line down (or leave in “1” state).

For the activation of the sensor the master needs to write an activation command (e.g. 0x09 to activate ALS and the PS with

1.1 Activate ALS (T_int_ALS = 100 ms, T_rep_ALS = 400 ms) and PS (T_rep_PS = 100 ms)

S	SFH7776 Address (0x39)	W	A	Mode_Control Register (0x41)	A	Activate ALS + PS Mode (0x09)	A	P
---	------------------------	---	---	------------------------------	---	-------------------------------	---	---

1.2 Set Proximity LED Current to 200 mA and ALS Gain to 64

* S	SFH7776 Address (0x39)	W	A	ALS_PS_Control Register (0x42)	A	ALS Gain + LED Current Mode (0x2B)	A	P
-----	------------------------	---	---	--------------------------------	---	------------------------------------	---	---

2. Sensor in Operation

3.1 Read Out PS Data (LSB)

S	SFH7776 Address (0x39)	W	A	PS Data Register (0x44)	A	P
---	------------------------	---	---	-------------------------	---	---

S	SFH7776 Address (0x39)	R	A	PS Data (LSB)	N	A	P
---	------------------------	---	---	---------------	---	---	---

3.2 Read Out PS Data (MSB)

S	SFH7776 Address (0x39)	W	A	PS Data Register (0x45)	A	P
---	------------------------	---	---	-------------------------	---	---

S	SFH7776 Address (0x39)	R	A	PS Data (MSB)	N	A	P
---	------------------------	---	---	---------------	---	---	---

4.1 Read Out ALS_VIS Data (LSB)

S	SFH7776 Address (0x39)	W	A	ALS Data Register (0x46)	A	P
---	------------------------	---	---	--------------------------	---	---

S	SFH7776 Address (0x39)	R	A	ALS Data (LSB)	N	A	P
---	------------------------	---	---	----------------	---	---	---

4.2 Read Out ALS_VIS Data (MSB)

S	SFH7776 Address (0x39)	W	A	ALS Data Register (0x47)	A	P
---	------------------------	---	---	--------------------------	---	---

S	SFH7776 Address (0x39)	R	A	ALS Data (MSB)	N	A	P
---	------------------------	---	---	----------------	---	---	---

4.3 Read Out ALS_IR Data (LSB)

S	SFH7776 Address (0x39)	W	A	ALS Data Register (0x48)	A	P
---	------------------------	---	---	--------------------------	---	---

S	SFH7776 Address (0x39)	R	A	ALS Data (LSB)	N	A	P
---	------------------------	---	---	----------------	---	---	---

4.4 Read Out ALS_IR Data (MSB)

S	SFH7776 Address (0x39)	W	A	ALS Data Register (0x49)	A	P
---	------------------------	---	---	--------------------------	---	---

S	SFH7776 Address (0x39)	R	A	ALS Data (MSB)	N	A	P
---	------------------------	---	---	----------------	---	---	---

W: Master Writes
R: Master Reads
A: Acknowledge
NA: Not Acknowledge
S: Start Condition
P: Stop Condition
* this line is optional

 Communication from Master to SFH 7776

 Communication from SFH 7776 to Master

Fig. 14: I²C-bus communication for the example described below.

T_int_ALS = 100 ms and repetition time of 400 ms and 100 ms for the PS) into the corresponding mode_control register (0x41). Each command needs to be acknowledged by the slave. After activation the master ends the communication with a STOP

command "P" (SDA line is changing from LOW to HIGH during SCL line stays HIGH). Additionally the ALS gain is set to 64 and PS current to 200 mA by writing 0x2B into the ALS_PS_Control register (0x42).

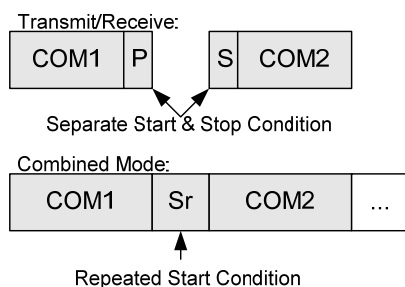

Fig. 15: Combined mode structure.

2. Sensor in Operation:

After activation, the sensor will change from STAND-BY to FREE-RUNNING mode. After a delay of e.g. 100 ms (depending on t_{INT_ALS} setting) the first measurement values are available and can be read via the I²C-bus.

3. PS value: reading data (LSB and MSB)

The two byte PS value is accessible via the output registers (0x44 (LSB) and 0x45 (MSB)). After reading the two 8-bit words, the communication can be ended by the master with a not acknowledge "NA" and the stop command "P". The two byte PS output readings of the SFH 7776 can then be converted to a final decimal PS value via Eq. (4):

$$DATA_{16bit, decimal} = DATA_{LSB} + 256 \cdot DATA_{MSB} \quad \text{Eq. (4)}$$

4. ALS value: reading data (LSB and MSB)

The sensor's two 16bit ALS measurement values are composed of 2 bytes each (LSB & MSB). The bytes are accessible via the two output registers (0x46 to 0x49). After addressing the LSB (least significant byte) resp. the MSB (most significant byte) output register, the communication direction has got to be changed from the slave to the master by repeating the address and the R/W byte with a changed R/W bit. After reading LSB and MSB, the communication is ended by the master with a not acknowledge "NA" and the stop condition "P". The conversion of the two byte output

data into 16bit values can easily be done by again using Eq. (4).

Finally the true lux value can be obtained from the two ALS data (ALS_VIS, ALS_IR) by using the simple instructions according to Eq. (1).

After finishing the measurement, the SFH 7776 mode may be changed to STAND-BY via the mode_control register.

Combined mode

To ensure interference free communication the I²C-bus combined mode should be used. Instead of performing two independent read or write commands (COM 1 & COM 2) the commands can be combined by a repeated start condition "Sr" (Fig. 15 illustrates the combined mode structure).

The start and repeated start commands ("Sr") are the same: the SDA line is changing from "1" to "0" during SCL line "1". The "Sr" condition is placed behind "A" or "NA". The combined mode is not limited to 2 read/write commands, so the addressing of the sensor and reading/writing of multiple register values can be performed within one block.

Block read/write mode

The Block read/write mode of the SFH 7776 can be used to read all output registers in cyclic manner.

After addressing and reading an output register (e.g. LSB) in normal mode, the master is not placing the stop condition, but sends an acknowledge and continues to read the output registers. The SFH 7776 will automatically increase the register address and the content of the next sensor output register can be read following the register addresses:

0x40 → 0x41 → ... → 0x51 → 0x52 → 0x40 → ...

For register addresses and content see Sec. 8.3 and Tab. 5.

The block read mode can be ended by placing a not acknowledge (NA) with the subsequent stop condition from the master.

I ² C Addr	Type	Name	Description
0x40	R/W	SYSTEM_CONTROL	System Control
0x41	R/W	MODE_CONTROL	ALS, PS General Control
0x42	R/W	ALS_PS_CONTROL	ALS Gain and PS Current Control
0x43	R/W	PERSISTENCE	PS Interrupt Persistence Control
0x44	R	PS_DATA_LSB	LSB data for PS
0x45	R	PS_DATA_MSB	MSB data for PS
0x46	R	ALS_VIS_DATA_LSB	LSB data for ALS VIS - diode
0x47	R	ALS_VIS_DATA_MSB	MSB data for ALS VIS - diode
0x48	R	ALS_IR_DATA_LSB	LSB data for ALS IR - diode
0x49	R	ALS_IR_DATA_MSB	MSB data for ALS IR - diode
0x4A	R/W	INTERRUPT_CONTROL	Interrupt Control
0x4B	R/W	PS_TH_LSB	PS interrupt up threshold level, LSB
0x4C	R/W	PS_TH_MSB	PS interrupt up threshold level, MSB
0x4D	R/W	PS_TL_LSB	PS interrupt low threshold level, LSB
0x4E	R/W	PS_TL_MSB	PS interrupt low threshold level, MSB
0x4F	R/W	ALS_VIS_TH_LSB	ALS (VIS) interrupt up threshold level, LSB
0x50	R/W	ALS_VIS_TH_MSB	ALS (VIS) interrupt up threshold level, MSB
0x51	R/W	ALS_VIS_TL_LSB	ALS (VIS) interrupt low threshold level, LSB
0x52	R/W	ALS_VIS_TL_MSB	ALS (VIS) interrupt low threshold level, MSB

Tab. 5: SFH 7776 control and data registers.

8.3 Registers

The SFH 7776 has 19 different registers (see Tab. 5).

The following pages will describe the registers and their structure resp. content.

SYSTEM_CONTROL: The SYSTEM_CONTROL register is used to control the software (SW) reset and the interrupt function (INT). Manufacturer ID and Part ID can be read.

RW-Register 0x40												
Bit	7			6			5	4	3	2	1	0
	SW reset			INT reset			Manufacturer ID (read only)			Part ID (read only)		
default	0	Initial rest is not started			0	INT pin status is not initialized			001			
	1	Initial reset started			1	INT pin become inactive (high impedance)						
							001					

MODE_CONTROL: Mode CONTROL for PS operating modes and time settings. Normal ALS measurement time is 100 ms. High sensitive ALS mode is with a true measurement time of 400 ms ($=t_{int_ALS}$). The 50 ms ALS integration time setting (1100) might lead to susceptibility to flicker and requires additional functionality in the software. This setting is not recommended by OSRAM OS.

RW-Register 0x41											
Bit	7	6	5	4		3	2		1	0	
	Reserved (read only)			PS Mode		Measurement Repetition Rate					
						ALS		PS			
default				0	normal	0000	standby		standby		
				1	two-pulse mode	0001	standby		10 ms		
						0010	standby		40 ms		
						0011	standby		100 ms		
						0100	standby		400 ms		
						0101	100 ms ($=t_{int_ALS}$)		standby		
						0110	100 ms ($=t_{int_ALS}$)		100 ms		
						0111	100 ms ($=t_{int_ALS}$)		400 ms		
						1000	400 ms ($t_{int_ALS}=100ms$)		standby		
						1001	400 ms ($t_{int_ALS}=100ms$)		100 ms		
						1010	400 ms ($=t_{int_ALS}$)		standby		
						1011	400 ms ($=t_{int_ALS}$)		400 ms		
						1100	50 ms ($=t_{int_ALS}$ *)		50 ms		
						else	forbidden				

*) to apply the 50 ms setting the following software handling of the ALS data is necessary before lux calculation can be performed (as bit # (15) indicates data overflow in 50 ms mode). Note that the max. count in 50 ms is 0x7FFF (15 bit long instead of 16):

```
If (ALS_VIS & 0x8000) == 0x8000 // bitwise AND to identify the overflow flag in bit 15 of ALS_VIS
{ALS_VIS = 0x7FFF;}
If (ALS_IR & 0x8000) == 0x8000 // bitwise AND to identify the overflow flag in bit 15 of ALS_IR
{ALS_IR = 0x7FFF;}
```

ALS_PS_CONTROL: Control to set the PS output, the ALS Gain and the LED current.

R/W-Register 0x42										
Bit	7	6	5	4	3	2	1	0		
	Reserved (read only)		PS Output		ALS Gain for ALS VIS and ALS IR			LED Current		
	Field		Bits	Default	Description					
	Reserved		7	0	0	Write 0				
	PS Output		6	0	0	Proximity output				
					1	Infrared DC level output				
	ALS Gain		5:2	0000	0000	ALS VIS: x 1 ALS IR: x 1				
					0100	ALS VIS: x 2 ALS IR: x 1				
					0101	ALS VIS: x 2 ALS IR: x 2				
					1010	ALS VIS: x 64 ALS IR: x 64				
					1110	ALS VIS: x 128 ALS IR: x 64				
					1111	ALS VIS: x 128 ALS IR: x 128				
					else	forbidden				
	LED Current		1:0	11	11	200 mA				
					00	25 mA				
					01	50 mA				
					10	100 mA				

PERSISTANCE: Settings of persistence interrupt function and interrupt status.

RW-Register 0x43								
Bit	7	6	5	4	3	2	1	0
	Reserved (read only)				Persistence			
default	0000				0001	Interrupt status updated after each measurement		
					0000	Interrupt becomes active after each measurement		
					0001	Interrupt status updated after each measurement		
					0010	Interrupt status is updated if two consecutive threshold judgement are the same		
					0011 or higher	Interrupt status is updated if threshold judgement are the same over n-consecutive times (n is set in bits (0:3))		

PS_DATA_LSB: LSB of the PS output.

R-Register 0x44								
Bit	7	6	5	4	3	2	1	0
	LSB data							
default	0000 0000							

PS_DATA_MSB: MSB of the PS output.

R-Register 0x45								
Bit	7	6	5	4	3	2	1	0
	MSB data							
default	0000 0000							

ALS_VIS_DATA_LSB: LSB of the ALS VIS output.

R-Register 0x46								
Bit	7	6	5	4	3	2	1	0
	LSB data							
default	0000 0000							

ALS_VIS_DATA_MSB: MSB of the ALS VIS output.

R-Register 0x47								
Bit	7	6	5	4	3	2	1	0
	MSB data							
default	0000 0000							

ALS_IR_DATA_LSB: LSB of the ALS IR output.

R-Register 0x48								
Bit	7	6	5	4	3	2	1	0
	LSB data							
default	0000 0000							

ALS_IR_DATA_MSB: MSB of the ALS IR output.

R-Register 0x49								
Bit	7	6	5	4	3	2	1	0
	MSB data							
default	0000 0000							

INTERRUPT CONTROL: Setting of the interrupt functions.

R/W-Register 0x4A							
Bit	7	6	5	4	3	2	1 0
	PS INT Status (read only)	ALS INT Status (read only)	INT Mode		INT assert	INT latch	INT trigger
Field	Bits	Default	Description				
PS INT status	7	0	0	PS interrupt signal inactive			
			1	PS interrupt signal active			
ALS INT status	6	0	0	ALS VIS interrupt signal inactive			
			1	ALS VIS interrupt signal active			
INT mode	5:4	00	00	PS_TH is only active			
			01	PS_TH & PS TL are active (Hysteresis)			
			10	PS_TH & PS TL are active as outside detection forbidden			
			11	forbidden			
INT assert	3	0	0	INT "L" is stable if newer measurement results is also interrupt active			
			0	INT "L" is de-assert and re-assert if newer measurement results is also interrupt active			
INT latch	2	0	0	INT is latched until INT register is read or initialized			
			1	INT is updated after each measurement			
Interrupt mode	1:0	00	00	INT pin is inactive			
			00	Triggered by PS only			
			10	Triggered by ALS VIS only			
			11	Triggered by PS or ALS only			

Note: Bits 6 & 7 (interrupt inactive / active) are reset as soon as register 0x4A is read. This is also valid for the INT-pin (becomes inactive as soon as register 0x4A is read).

PS_TH_LSB: LSB for the PS threshold „HIGH“.

RW-Register 0x4B							
Bit	7	6	5	4	3	2	1 0
	LSB data (upper threshold)						
default	1111 1111						

PS_TH_MSB: MSB for the PS threshold „HIGH“.

RW-Register 0x4C							
Bit	7	6	5	4	3	2	1 0
	MSB data (upper threshold)						
default	1111 1111						

PS_TL_LSB: LSB for the PS threshold „LOW“.

RW-Register 0x4D							
Bit	7	6	5	4	3	2	1 0
	LSB data (lower threshold)						
default	0000 0000						

PS_TL_MSB: MSB for the PS threshold „LOW“.

RW-Register 0x4E							
Bit	7	6	5	4	3	2	1 0
	MSB data (lower threshold)						
default	0000 0000						

ALS_VIS_TH_LSB: LSB for the ALS_VIS threshold „HIGH“.

RW-Register 0x4F							
Bit	7	6	5	4	3	2	1 0
	LSB data (upper threshold)						
default	1111 1111						

ALS_VIS_TH_MSB: MSB for the ALS_VIS threshold „HIGH“.

RW-Register 0x50								
Bit	7	6	5	4	3	2	1	0
	MSB data (upper threshold)							
default	1111 1111							

ALS_VIS_TL_LSB: LSB for the ALS_VIS threshold „LOW“.

RW-Register 0x51								
Bit	7	6	5	4	3	2	1	0
	LSB data (lower threshold)							
default	0000 0000							

ALS_VIS_TL_MSB: MSB for the ALS_VIS threshold „LOW“.

RW-Register 0x52								
Bit	7	6	5	4	3	2	1	0
	MSB data lower threshold)							
default	0000 0000							

9. Interrupt Alert

The SFH 7776 provides an interrupt pin which can be configured completely by the user (access via register 0x4A). E.g. the interrupt function can be configured to operate in latched or normal mode. In normal mode the interrupt event/signal is updated after every measurement, whereas in the latched mode it is guaranteed that even single peaks are detected (e.g. the interrupt is held as long as the microcontroller reads out the interrupt register). Other options include the selection of the interrupt trigger source (PS or/and

ALS) as well as the option of having PS hysteresis (e.g. in combination with a persistence function) and/or an ALS_VIS event window (upper and lower ALS_VIS threshold). For the exact interrupt event definition please refer to Tab. 6. This is especially valuable as it allows the SFH 7776 to operate as stand alone device in the *free-running mode*, independent from the main microcontroller. This functionality relieves the microcontroller from active involvement in the PS / ALS monitoring resp. measurement cycle and reduces significantly the I²C-bus traffic, thus reducing the overall power consumption of the

Interrupt Event Definition		
proximity sensor	Without Hysteresis:	
	ON:	PS data > PS_TH (threshold high)
	OFF:	PS data < PS_TH (threshold high)
	With Hysteresis:	
	ON:	PS data > PS_TH (threshold high)
	OFF:	PS data < PS_TL (threshold low)
ambient light sensor	Interval:	
	ON:	ALS_VIS > ALS_VIS_TH (threshold high) or ALS_VIS < ALS_VIS_TL (threshold low)
	OFF:	ALS_VIS_TL < ALS_VIS < ALS_VIS_TH

Tab. 6: Interrupt event definition. Note that the on/off definition of the PS can be inverted by user setting within register (0x4A) to allow switching from inside target to outside target detection.

system. Only if the user-defined thresholds are violated, the interrupt signal will inform the microcontroller and the predefined actions can be executed (e.g. after optional read-out of the interrupt and PS / ALS data registers to get the actual data - if desired).

Note: Interrupt pin level and bits 6 & 7 of register 0x4A (Interrupt register) are reset as soon as interrupt register 0x4A is read.

10 Design-in Guidelines

By implementing the SFH 7776 behind a (dark) cover glass, three issues need to be taken into account:

- ALS: ambient light calculation
- PS: maximum detection distance
- ALS & PS: aperture design

The following sections deal with these issues and give the designer valuable guidelines to achieve the maximum performance of the sensor.

10.1 Implementing the Illumination (Lux) Calculation: General Procedure

The design of the sensor allows computing from the two ALS data sets (ALS_VIS and ALS_IR) the “true” ALS value in front of a (“dark”) cover glass.

In general the calculation of the lux value is based on a set of equations which are typically derived by measurements and some mathematics. This set of equations looks like:

```

IF (ALS_IR / ALS_VIS) < r_0
  LUX = (a_0 * ALS_VIS / GAIN_VIS
        - b_0 * ALS_IR / GAIN_IR)

ELSE IF (ALS_IR / ALS_VIS) < r_1
  LUX = (a_1 * ALS_VIS / GAIN_VIS
        - b_1 * ALS_IR / GAIN_IR )

ELSE IF (ALS_IR / ALS_VIS) < r_2
  LUX = (a_2 * ALS_VIS / GAIN_VIS
        - b_2 * ALS_IR / GAIN_IR )

```

```

ELSE IF (ALS_IR / ALS_VIS) < (0.95* r_3)
  LUX = (a_3 * ALS_VIS / GAIN_VIS
        - b_3 * ALS_IR / GAIN_IR )

ELSE IF (ALS_IR/ALS_VIS) < (1.5 * r_3)
  LUX = (2 * a_3 * ALS_VIS / GAIN_VIS
        - 1.18 * b_3 * ALS_IR / GAIN_IR)

ELSE IF (ALS_IR/ALS_VIS) < (2.5 * r_3)
  LUX = (4 * a_3 * ALS_VIS / GAIN_VIS
        - 1.33 * b_3 * ALS_IR / GAIN_IR)

ELSE
  LUX = (8 * a_3 * ALS_VIS / GAIN_VIS)

LUX = LUX * 100 ms / T_INT_ALS

```

Eq. (5)

The first case (indicated by $ALS_IR / ALS_VIS < r_0$) covers e.g. LED, fluorescence and sunlight based lighting situations. The second case ($< r_1$) handles incandescent and halogen lamps, whereas cases three ($< r_2$) and four ($< 0.95 \cdot r_3$) cover dimmed halogen and incandescence lamps, characterized by increased IR content.

The following cases ($< (1.5 \cdot r_3)$ and $< (2.5 \cdot r_3)$) need always to be added as the final ELSE IF condition to compensate for titled situations and relate to the last constants (in this case to r_3 , a_3 and b_3). The same holds true for the final ELSE statement (a_3 always relates to the constant a of the last ELSE IF statement).

The way to obtain the parameters of the equations is governed by four steps:

- 1) measurement under different lighting conditions
- 2) harmonization of results and plotting
- 3) grouping and linear approximation
- 4) derive set of final equations for illumination calculation

In the following pages this procedure is described in more detail:

- 1) Based on a setup according to Fig. 16 the illumination value $E_{V_Measured}$ (in lux) in front

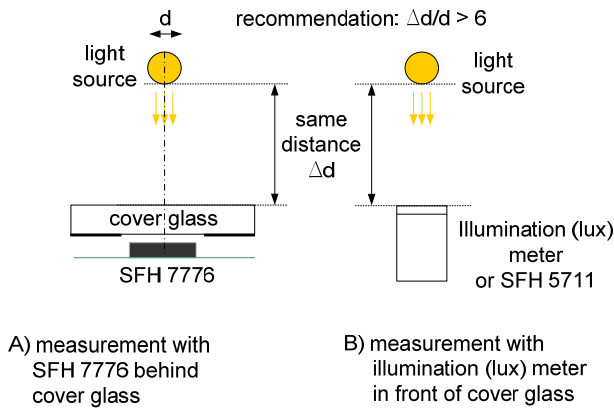

Fig. 16: Measurement setup for deriving the required equations to calculate the illumination (lux) value out of ALS_VIS, ALS_IR.

of the cover is recorded in parallel to the readings of ALS_VIS resp. ALS_IR (with appropriate settings of ALS gain to avoid saturation resp. too low counts); see Tab. 7. This needs to be performed with various different light sources
 For best results it is recommended that the light source dimension d is small compared to Δd , the distance light source – SFH 7776. Recommended is $\Delta d/d > 6$. If this can not be achieved a mechanical aperture in the optical path is recommended.

2) The next step comprises a harmonization of the results, considering normalizing all

obtained data to the same ALS gain setting resp. t_{INT_ALS} setting (100 ms or 400 ms). A recommended approach is to normalize all measurements to e.g. 100 ms, unity gain ($GAIN_ALS_VIS = GAIN_ALS_IR = 1$) and to identical illumination value E_{v_norm} (e.g. 1 lux). In essence it means to normalize the measured ALS_VIS and ALS_IR data (see also Tab. 7) by using:

$$ALS_VIS = \frac{ALS_{VIS_MEASURED}}{E_{v_Measured} (in\ lux)} \cdot \frac{100\ ms}{t_{INT_ALS} \cdot GAIN_{VIS}}$$

Eq. (6)

$$ALS_IR = \frac{ALS_{IR_MEASURED}}{E_{v_Measured} (in\ lux)} \cdot \frac{100\ ms}{t_{INT_ALS} \cdot GAIN_{IR}}$$

Eq. (7)

The obtained data points from Eqs. (6) and (7) are now plotted into a diagram (ALS_IR vs. ALS_VIS) like in Fig. 17.

3) The next step is to group the data points together like seen in Fig. 17 and derive the linear approximation equation for each group. Recommended grouping / linearization could combine light sources with similar properties, e.g. combine white LEDs and fluorescence lamps. Next group could be halogen and traditional incandescent lamps. The final group(s) could be dimmed incandescent light sources

	Fluorescence Lamp	White LED	Halogen Lamp	Incand. Lamp	Dimmed Incand. Lamp	Dimmed Halogen Lamp	Sunlight
Illumination in Front of Cover / lux	215	6750	245	185	118	26	100000
Gain Setting	64	2	64	2	2	128	1
ALS_VIS_measured	1320	1500	9200	425	970	3400	28000
ALS_IR_measured	65	35	7700	360	1360	2700	15000
	↓	↓	↓ via Eqs. (6) and (7) ↓			↓	↓
ALS_VIS *)	0.096	0.111	0.587	1.149	4.110	1.022	0.280
ALS_IR *)	0.005	0.003	0.491	0.973	5.763	0.811	0.150
ALS_IR / ALS_VIS Ratio	0.049	0.023	0.837	0.847	1.402	0.794	0.536

Tab. 7: Example of measured ALS data for various light sources and their normalized values (measured with a cover glass transmission acc. to Fig. 18).
 *) normalized to 1 lux and gain = 1.

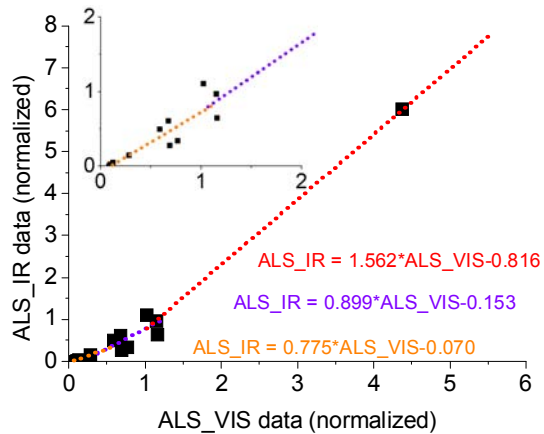

Fig. 17: Graph representing the normalized ALS data points (according to Eq. (6) and (7)). The linear approximation is done here with e.g. three linear segments and corresponds to a cover glass according to Fig. 18. Inset: Zoomed area at low ALS data.

as their IR/VIS ratio is the highest.

The mathematical syntax is as follows for the linear approximation (resulting in N+1 equations):

Group 0:

$$ALS_{IR} = c_0 \cdot ALS_{VIS} - d_0$$

Group 1:

$$ALS_{IR} = c_1 \cdot ALS_{VIS} - d_1$$

...

Group N:

$$ALS_{IR} = c_N \cdot ALS_{VIS} - d_N$$

Eq. (8)

4) Now the linearization Eqs. (8) are compared with the original illumination (lux) Eqs. to derive the constant values:

Group 0:

$$LUX = a_0 \cdot ALS_{VIS} - b_0 \cdot ALS_{IR}$$

Group 1:

$$LUX = a_1 \cdot ALS_{VIS} - b_1 \cdot ALS_{IR}$$

....

Group N:

$$LUX = a_N \cdot ALS_{VIS} - b_N \cdot ALS_{IR}$$

Eq. (9)

The two sets of equations (8 and 9) can be solved to determine the constant values a_n resp. b_n . The result is as follows with E_{v_norm} as the normalized illumination in lux (i.e. $E_{v_norm} = 1$ lx; according to step 3).

$$a_i = E_{v_norm} \cdot c_i / d_i \quad \text{Eq. (10)}$$

$$b_i = E_{v_norm} / d_i \quad \text{Eq. (11)}$$

The constant values (a , b) in Eqs. (9) are now determined. The last step is to define the threshold level r_n at which point one equation is replaced by the next one:

$$r_0 = \frac{ALS_{IR}}{ALS_{VIS}} = \frac{(a_0 - a_1)}{(b_0 - b_1)}$$

$$r_1 = \frac{ALS_{IR}}{ALS_{VIS}} = \frac{(a_1 - a_2)}{(b_1 - b_2)}$$

...

$$r_N = \frac{ALS_{IR}}{ALS_{VIS}} = \frac{(a_N - 0)}{(b_N - 0)}$$

Eq. (12)

The final instruction set for implementation now need to take again into account any different settings (gain, t_{INT_ALS}) under which the sensor is operated and look like:

```

IF (ALS_IR / ALS_VIS) < r_0
    LUX = (a_0 * ALS_VIS / GAIN_VIS
          - b_0 * ALS_IR / GAIN_IR)

ELSE IF (ALS_IR / ALS_VIS) < r_1
    LUX = (a_1 * ALS_VIS / GAIN_VIS
          - b_1 * ALS_IR / GAIN_IR )

ELSE IF (ALS_IR / ALS_VIS) < r_2
    LUX = (a_2 * ALS_VIS / GAIN_VIS
          - b_2 * ALS_IR / GAIN_IR )

ELSE IF (ALS_IR / ALS_VIS) < (0.95 * r_3)
    LUX = (a_3 * ALS_VIS / GAIN_VIS
          - b_3 * ALS_IR / GAIN_IR )

ELSE IF (ALS_IR/ALS_VIS) < (1.5 * r_3)
    LUX = (2 * a_3 * ALS_VIS / GAIN_VIS
          - 1.18 * b_3 * ALS_IR / GAIN_IR)

ELSE IF (ALS_IR/ALS_VIS) < (2.5 * r_3)

```

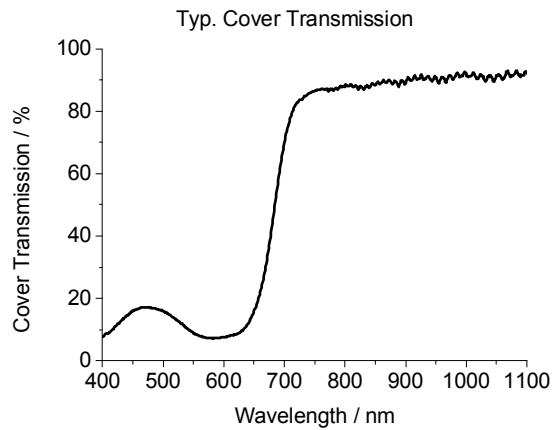

Fig. 18: Typ. cover glass transmission characteristics.

$$\text{LUX} = (4 * a_3 * \text{ALS_VIS} / \text{GAIN_VIS} - 1.33 * b_3 * \text{ALS_IR} / \text{GAIN_IR})$$

Else

$$\text{LUX} = 8 * a_3 * \text{ALS_VIS} / \text{GAIN_VIS}$$

$$\text{LUX} = \text{LUX} * 100 \text{ ms} / \text{T_INT_ALS}$$

Eq. (13)

Note 1: the above threshold condition via r_n is valid for having equal gain setting between GAIN_VIS and GAIN_IR in the application. If gain is set unequal, the threshold levels r_n need to be divided by a factor of two.

Note 2: To achieve the necessary accuracy during this procedure it is mandatory not to change the number of decimal places or in other words not to change the accuracy of the numbers.

10.2 Implementing the Illumination (Lux) Calculation: Example

Next is a *practical example* with a cover glass featuring transmission characteristics according to Fig. 18.

- 1) Measuring of the ALS data according to the setup in Fig. 16 (see Tab. 7)
- 2) Normalization according to Eqs. (6) and (7) and data point plotting (see Tab. 7 and Fig. 17).

- 3) In this case a three-segment linear approximation (see Fig. 17) has been chosen.
- 4) Deriving the final constants / equations - Eqs. (10) to (12) - like previously described:

$$\text{IF } (\text{ALS_IR} / \text{ALS_VIS}) < 0.670 \\ \text{LUX} = (11.071 * \text{ALS_VIS} / \text{GAIN_VIS} - 14.286 * \text{ALS_IR} / \text{GAIN_IR})$$

$$\text{ELSE IF } (\text{ALS_IR} / \text{ALS_VIS}) < 0.746 \\ \text{LUX} = (5.876 * \text{ALS_VIS} / \text{GAIN_VIS} - 6.536 * \text{ALS_IR} / \text{GAIN_IR})$$

$$\text{ELSE IF } (\text{ALS_IR}/\text{ALS_VIS}) < (0.95 * 1.56) \\ \text{LUX} = (1.914 * \text{ALS_VIS} / \text{GAIN_VIS} - 1.225 * \text{ALS_IR} / \text{GAIN_IR})$$

$$\text{ELSE IF } (\text{ALS_IR}/\text{ALS_VIS}) < (1.5 * 1.56) \\ \text{LUX} = (2.0 * 1.914 * \text{ALS_VIS} / \text{GAIN_VIS} - 1.18 * 1.225 * \text{ALS_IR} / \text{GAIN_IR})$$

$$\text{ELSE IF } (\text{ALS_IR}/\text{ALS_VIS}) < (2.5 * 1.56) \\ \text{LUX} = (4.0 * 1.914 * \text{ALS_VIS} / \text{GAIN_VIS} - 1.33 * 1.225 * \text{ALS_IR} / \text{GAIN_IR})$$

Else

$$\text{LUX} = 8 * 1.914 * \text{ALS_VIS} / \text{GAIN_VIS}$$

$$\text{LUX} = \text{LUX} * 100 \text{ ms} / \text{T_INT_ALS}$$

Eq. (14)

The typical accuracy of this implementation is around $\pm 20\%$ for various light sources.

10.3 Proximity Sensor Detection Distance behind a Dark Cover Glass

Implementing the sensor behind a dark cover glass influences directly the detection range of the sensor.

It is important to mention that a reduced IR transmission at 850 nm through a dark cover glass also reduces the maximum detection distance (compared to the case that the sensor is operated without any cover).

As light from the sensor passes the cover glass twice (on the way to the target plus on its way back to the sensor) it reduces the

Cover Glass Transmission (at IR)	Corresponding Detection Distance (Approximation)
100 % (no glass)	100 %
90 % (clear glass)	90 %
x %	x %

Tab. 8: Impact of one-way cover glass (IR-) transmission on PS detection range (assuming a sufficiently large reflector size).

proximity signal PS at sensor site by $\sim T^2$ with T as the one way cover transmission (e.g. $T = 0.9$ for 90 %). For most scenarios the relationship between proximity signal PS and detection distance d is: $PS \sim 1/d^2$ (see also Fig. 8 to 10). Combining both relations results in: $PS \sim T^2/d^2$. To achieve the same sensor signal level (counts) means that the max. detection distance is reduced by the same percentage as the cover glass' one way transmission.

As a rule of thumb, an x % one way transmission loss reduces the detection range by around x % as well (compared to not using any cover glass at all). Please refer to Tab. 8 for an approximate relationship between detection distance (e.g. threshold) and cover glass IR transmission.

To compensate for, it is recommended to increase the LED current or/and lower the PS threshold level in the relevant register.

10.4 Zero-Distance Detection

The sensors proprietary design features zero-distance touch detection. In essence the sensor delivers enough PS counts to ensure a reliable operation. This unique feature allows for easy design-in. Typical PS counts for a human finger at zero-distance are e.g. 800 counts (finger directly on sensor at 200 mA IR-LED current) resp. around 500 counts (directly on cover glass at 200 mA IR-LED current), way above any

typ. threshold setting. This is valid for human skin but not necessarily for any arbitrary reflector.

10.5 Design of the Cover Glass' Aperture Opening

To ensure a fully functional design (primarily to achieve the desired level of PS crosstalk-immunity but also to achieve a certain receptive angle of the ALS) a two-hole aperture design is recommended. Compared to a single (oval) - hole design the two-hole approach delivers less (dark) ink-dependent crosstalk and improves the crosstalk-free range.

Please refer to Fig. 5 resp. 11 for the detector directivity and the radiation characteristics of the IR-LED (emitter).

To achieve the maximum switching distance, the recommended minimum aperture diameter of the cover glass opening depends on the airgap and can be calculated according to:

$$\varnothing \geq 2 \cdot (\Delta d + 0.45 \text{ mm}) \cdot \tan 35^\circ \quad \text{Eq. (15)}$$

Δd is the airgap between the top surface of the SFH 7776 and the bottom of the cover glass where the aperture is located (see also Fig. 19). The maximum recommended aperture diameter is in the range of up to 2.0 mm to 1.8 mm to ensure a stable crosstalk-insensitive design, with effective multipath suppression.

However these dimensions don't consider any manufacturing tolerances.

Note that the proximity sensor alone works also with smaller apertures; but a too small aperture ($\varnothing \ll 1.0 \text{ mm}$) might impact the max. detection distance and limit the ambient light sensors angular sensitivity.

The required aperture opening diameter has been minimized in order to reduce the cover glass aperture opening size required for maximum performance. This feature improves the visual impression of the mobile device by keeping the sensor invisible for

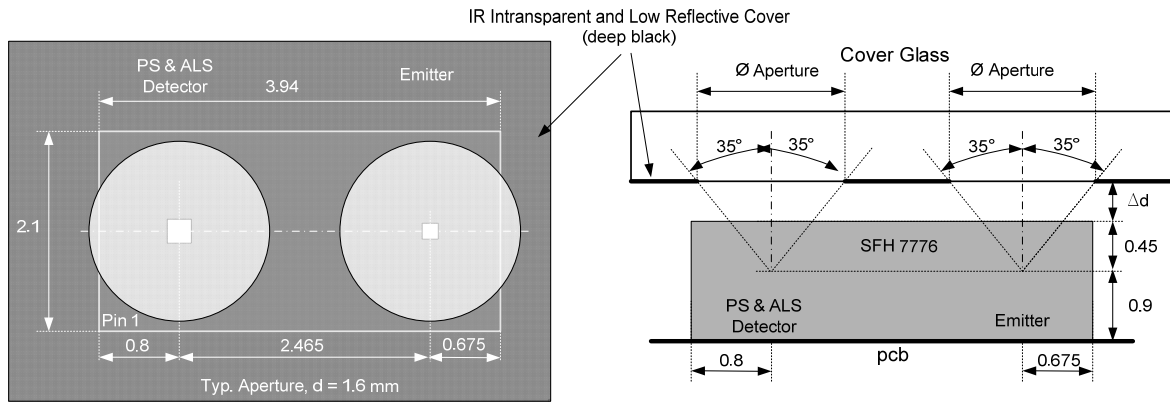

Fig. 19: Circular aperture design for a cover glass. The above values represent an arrangement without considering mechanical tolerances. The minimum recommended aperture diameter can be calculated to be $\varnothing \geq 2 \cdot (\Delta d + 0.45\text{mm}) \cdot \tan 35^\circ$ with Δd as the airgap. Performance evaluation is recommended in any case to verify the viability of the design. Note that the sensor also performs in a less than ideal environment (e.g. smaller apertures), but this might lead to a decrease in maximum detection distance. In general, to achieve crosstalk-insensitivity, OSRAM recommends limiting the airgap to below 0.5 mm (please refer to Fig. 12). Low reflective structures are recommended in the vicinity of the sensor for optimized performance.

users. On the other hand the sensors design ensures that a direct touch with a human hand is still detected (e.g. zero-distance detection capability).

For the typical case of an airgap of 0.2 mm OSRAM recommends to use an aperture opening of e.g. 1.6 mm. Fig. 19 illustrates the above recommendations by utilizing an \varnothing 1.6 mm aperture.

A single-hole (oval) aperture design also works, but - depending on the quality of the dark ink – might result in an additional crosstalk (some counts) compared to a two-hole solution.

Further it is recommended to apply an IR intransparent / low reflective coating (e.g. dark black) on the bottom side of the cover glass. In general it is mandatory for an optimized crosstalk-insensitive performance that the immediate vicinity of the sensor is also low reflective (e.g. dark black). In this context OSRAM recommends to avoid placing the sensor close to other

components or objects as their reflections might impair the performance of the sensor.

10.6 Electrical Circuit and Layout Considerations

Fig. 20 illustrates a recommendation for implementing the SFH 7776 into a mobile phone environment.

To achieve maximum sensitivity concerning the proximity functionality it is mandatory to have a stable (battery-like) power supply. The recommendation therefore is to connect V_{LED} directly to the battery. This ensures the necessary LED current during the pulsed operation (up to 200 mA peak, depending on the actual settings of the proximity sensor's LED current). It is further recommended to use capacitors as close to the component as possible. Typ. values are 10 μF at the V_{LED} side (for up to 200 mA pulse current) and 100 nF for the V_{DD} circuit (ASIC supply). The 10 μF capacitor depends on the impedance of the voltage source and can e.g. be reduced if the LED pulse current is reduced to lower levels, e.g. 50 mA.

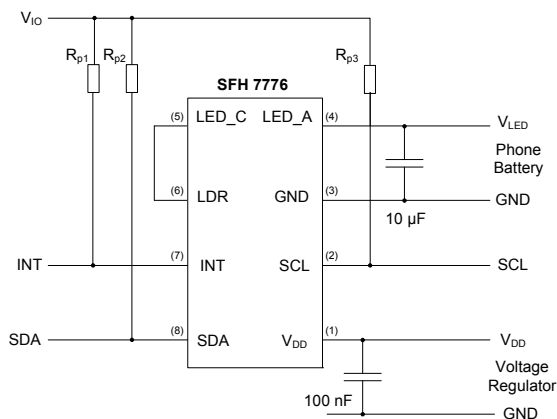

Fig. 20: Recommended implementation into a mobile phone environment.

This is especially important in a **laboratory environment** as regulated power supplies often have poor pulse current capabilities.

The SCL, SDA and INT lines require pull-up resistors to the logic voltage (V_{IO}). The limits for the logic levels are according to the I²C-bus specification (1.65 V to 2.0 V) [2]. A recommended value for R_p is e.g. 10 k Ω . Please note the actual value of the pull-up resistor depends - among other issues - on the total load and communication speed of the I²C-bus.

Fig. 21 presents a reference soldering-pad design. Please refer to the SFH 7776 datasheet for the most up-to-date recommendation.

11. Device Handling and Cleaning

In order to protect the semiconductor chips from environmental influences, e.g. in the soldering environment, a tape based encapsulant is used. Since this tape is very elastic and soft, mechanical stress or damage to the tape should be avoided during processing/assembly. The tape must not be removed under any circumstances.

Excessive force applied to the cover (tape) can lead to a spontaneous failure of the component (damage to the contacts). To

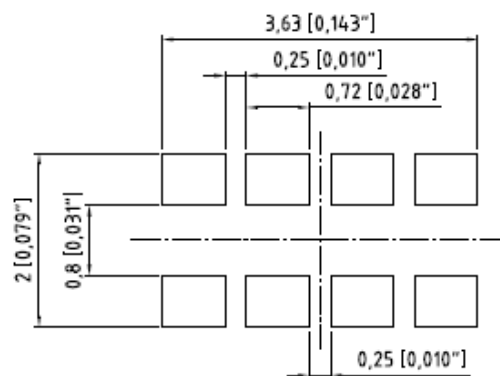

21: Recommended soldering pad design.

prevent damaging or puncturing the tape, the use of all types of sharp objects should be avoided both in the laboratory and factory environments.

Cleaning

In general, OSRAM Opto Semiconductors **does not recommend a wet cleaning process** for components like the SFH 7776 as the package is not hermetically sealed.

Due to the open design, all kind of cleaning liquids can infiltrate the package and cause degradation or a complete failure of the component. It is also recommended to prevent penetration of organic substances from the environment which could interact with the hot surfaces of the operating chips. Ultrasonic cleaning is generally not recommended for all types of LEDs (see also the application note "Cleaning of LEDs").

As is standard for the electronic industry, OSRAM Opto Semiconductors recommends using low-residue or no-clean solder paste, so that PCB cleaning after soldering is no longer required.

In any case, all materials and methods should be tested beforehand in order to determine whether the component will be damaged in the process.

12. Sample Software Code

Below are simple C-codes which can be used to operate the SFH 7776 in connection with a microcontroller (e.g. PIC18F46J50 from Microchip). The program consists of

the commented main micro C-code for the microcontroller, using the two subroutines

I2C_w_3: 3 write statements
I2C_w_2_r_1: 2 write and 1 read statement.

The main program can be implemented into a repeating loop to get the actual PS resp. ALS data or operate in interrupt mode.

12.1 Operating the ALS

12.1.1 C-code in main program:

```
sfh_address = 0x39; // address of SFH 7776
I2C_w_3 (sfh_address*2, 0x41, 0x08); // initiate ALS: 400ms rep rate, T_int=100ms
I2C_w_3 (sfh_address*2, 0x42, 0x28); // set ALS_VIS=ALS_IR GAIN = 64
I2C_w_2_r_1 (sfh_address*2, 0x46); // read lsb of ALS_VIS, register 0x46
Content1 = Content;
I2C_w_2_r_1 (sfh_address*2, 0x47); // read msb of ALS_VIS, register 0x47
ALS_VIS = (Content * 256 + Content1); // combining LSB+MSB byte to decimal value
I2C_w_2_r_1 (sfh_address*2, 0x48); // read lsb of ALS_IR, register 0x48
Content1 = Content;
I2C_w_2_r_1 (sfh_address*2, 0x49); // read msb of ALS_IR, register 0x49
ALS_IR = (Content * 256 + Content1); // combining LSB+MSB byte to decimal value

// Lux Calculation based on ALS Gain = 64 and ALS_Int_Time = 100 ms
// Lux value in front of sensor, no cover glass

IF ((ALS_IR / ALS_VIS) < 0.109)
    {LUX = (1.534 * ALS_VIS / 64 - 3.759 * ALS_IR / 64) * 1};
ELSE IF ((ALS_IR / ALS_VIS) < 0.429)
    {LUX = (1.339 * ALS_VIS / 64 - 1.972 * ALS_IR / 64) * 1};
ELSE IF ((ALS_IR/ALS_VIS) < (0.95 * 1.45))
    {LUX = (0.701 * ALS_VIS / 64 - 0.483 * ALS_IR / 64) * 1};
ELSE IF ((ALS_IR/ALS_VIS) < (1.5 * 1.45))
    {LUX = (2 * 0.701 * ALS_VIS / 64 - 1.18 * 0.483 * ALS_IR / 64) * 1};
ELSE IF ((ALS_IR/ALS_VIS) < (2.5 * 1.45))
    {LUX = (4 * 0.701 * ALS_VIS / 64 - 1.33 * 0.483 * ALS_IR / 64) * 1};
Else {LUX = 8 * 0.701 * ALS_VIS / 64};
```

12.1.2 I2C_w_3 subroutine

```
void I2C_w_3 (unsigned char addw, unsigned char com, unsigned char daw)
{
    unsigned char var;
    OpenI2C (MASTER, SLEW_ON); // Configures I2C bus module, 100 kHz transfer
    SSP1ADD = 0x27; // setting I2C 100 kHz frequency with f osc = 16 MHz
    StartI2C (); // Generates I2C bus start condition
    IdleI2C (); // Loop till I2C bus is idle
    var = WriteI2C(addw); // Microchips' Write command to write device address
    if (var == 0) write_s++; // var = 0: no bus error
    if (var == -1) write_c++; // var = -1: slave did not acknowledge write
    if (var == -2) write_ac++; // var=-2:write collision (bus not ready to tx)
    if (var < 0) goto stop; // stop further transmission if error occurred

    var = WriteI2C(com); // write device register address
    if (var == 0) write_s++; // counting of good transmissions
    if (var == -1) write_c++; // counting of no acknowledge errors
    if (var == -2) write_ac++; // counting of write collision errors
    if (var < 0) goto stop;

    var = WriteI2C(daw); // write register content
    if (var == 0) write_s++;
```

```

    if (var == -1) write_c++;
    if (var == -2) write_ac++;

    stop:
    StopI2C ();           // generates I2C bus stop condition
    CloseI2C ();         // master I2C module disabled
}

```

12.1.3 Subroutine I2C_w_2_r_1

```

void I2C_w_2_r_1 (unsigned char addr, unsigned char com)
{
    unsigned char var;
    OpenI2C (MASTER, SLEW_ON);
    SSPADD = 0x27;
    StartI2C ();
    IdleI2C ();
    var = WriteI2C(addr);
    if (var == 0) read_s++;
    if (var == -1) read_c++;
    if (var == -2) read_ac++;
    if (var < 0) goto stop;

    var = WriteI2C(com);
    if (var == 0) read_s++;
    if (var == -1) read_c++;
    if (var == -2) read_ac++;
    if (var < 0) goto stop;

    RestartI2C ();       // generates I2C bus restart condition
    IdleI2C ();
    var = WriteI2C(addr+1);
    if (var == 0) read_s++;
    if (var == -1) read_c++;
    if (var == -2) read_ac++;
    if (var < 0) goto stop;
    Content = 0;
    Content = ReadI2C ();
    SSPCON2bits.ACKDT = 1;           // No master Acknowledge to terminate sequence
    SSPCON2bits.ACKEN = 1;         // sending No Acknowledge bit
    PIR1bits.SSPIF = 0;
    while (SSPCON2bits.ACKEN == 1);
    PIR1bits.SSPIF = 0;           // waiting till NA causes interrupt
    stop:
    StopI2C ();
    CloseI2C ();
}

```

12.2 Operating the PS

Below is a small C-code for the main program to operate the proximity sensor of the SFH 7776. The two subroutines, I2C_w_3 and I2C_w2_r1 are the same as above (see Sec. 12.1.2 and 12.1.3).

C-code for main program:

```

sfh_address = 0x39;           // address of SFH 7776
I2C_w_3 (sfh_address*2, 0x41, 0x03); // initialize PS (100ms repetition rate)
I2C_w_3 (sfh_address*2, 0x42, 0x30); // run PS with 200 mA IR LED current
I2C_w_2_r_1 (sfh_address*2, 0x44); // read LSB data byte of PS, register 0x44
PS = Content;
I2C_w_2_r_1 (sfh_address*2, 0x45); // read MSB data byte of PS, register 0x45
PS = (PS + Content* 256); // combining low+high byte to decimal value

```

12.3 Operating the ALS and PS in Interrupt Mode

The small C-code below operates the SFH 7776 in the interrupt mode. The ALS and PS are in free-running mode. The interrupt event can occur through an ALS or PS event. The interrupt event limits for ALS and PS are to be set within the program (variables: `LSB_UP`, `MSB_UP`, `LSB_LOW`, `MSB_LOW`, `LSB_Prox_Limit_Int_On`, `MSB_Prox_Limit_Int_On`, `LSB_Prox_Limit_Int_Off`, `MSB_Prox_Limit_Int_Off`). After the interrupt has triggered the microcontroller the relevant sensor is determined and the ALS or PS value is read out. The calculated illumination value (`lux`) assumes no cover above the sensor.

C-code for main program:

```
// General:
I2C_w_3      (0x39*2, 0x41, 0x09);
// ALS: 400ms repetition rate, T_int=100ms, PS: 100ms repetition rate
I2C_w_3      (0x39*2, 0x42, 0x2B);      // ALS gain: 64, PS current = 200mA
I2C_w_3      (0x39*2, 0x4A, 0x13);      // set interrupt
// interrupt triggered by PS hysteresis and ALS, latched

// ALS:
I2C_w_3      (0x39*2, 0x4F, LSB_UP);      // setting LSB of upper ALS_VIS limit
I2C_w_3      (0x39*2, 0x50, MSB_UP);      // setting MSB of upper ALS_VIS limit
I2C_w_3      (0x39*2, 0x51, LSB_LOW);     // setting LSB of lower ALS_VIS limit
I2C_w_3      (0x39*2, 0x52, MSB_LOW);     // setting MSB of lower ALS_VIS limit

// Prox:
I2C_w_3      (0x39*2, 0x4B, LSB_Prox_Limit_Int_On); // LSB for prox INT-ON limit
I2C_w_3      (0x39*2, 0x4C, MSB_Prox_Limit_Int_On); // MSB for prox INT-ON limit
I2C_w_3      (0x39*2, 0x4D, LSB_Prox_Limit_Int_Off); // LSB for prox INT-OFF limit
I2C_w_3      (0x39*2, 0x4E, MSB_Prox_Limit_Int_Off); // MSB for prox INT-OFF limit

// Interrupt routine: // called when interrupt happened

I2C_w_2_r_1 (0x39*2, 0x4A);
// reading Interrupt (Status) Register,
// Function returns register value as variable Content
if ( (Content & 0x53) == 0x53)
// &=bitwise AND,check whether ALS triggered interrupt
{
    I2C_w_2_r_1 (0x39*2, 0x46); // read LSB of ALS_VIS, register 0x46
    Content1 = Content;
    I2C_w_2_r_1 (0x39*2, 0x47); // read MSB of ALS_VIS, register 0x47
    ALS_VIS = (Content * 256 + Content1); // calc ALS_VIS in decimal
    I2C_w_2_r_1 (0x39*2, 0x48); // read LSB of ALS_IR, register 0x48
    Content1 = Content;
    I2C_w_2_r_1 (0x39*2, 0x49); // read MSB of ALS_IR, register 0x49
    ALS_IR = (Content * 256 + Content1); // calc ALS_IR in decimal

    // Lux Calculation based on ALS Gain = 64 and ALS_Int_Time = 100 ms
    // Lux value in front of sensor, no cover glass
    // REFER TO EQ. (1) for the set of Instructions
}
if ( (Content & 0x93) == 0x93)
// &=bitwise AND,check whether PS triggered interrupt
{
    I2C_w_2_r_1 (0x39*2, 0x44); // read LSB of PS, register 0x44
    ContentP = Content;
    I2C_w_2_r_1 (0x39*2, 0x45); // read MSB of PS, register 0x45
    PS = Content * 256 + ContentP;
}
// end of interrupt routine
```

12.4 Implementation into a Mobile Phone Environment

Below are two example flowcharts, describing how the SFH 7776 can be implemented into a microcontroller based mobile phone environment. The interrupt function allows for low-power stand-alone operation of the device.

The first flowchart illustrates a possible operation of the proximity sensor, the second flowchart relates to the operation of the ambient light sensor.

12.4.1 Operation of the PS

Fig. 22 illustrates the flowchart for a microcontroller based proximity-only sensing example.

The interrupt alerts the microcontroller only in case an object passes a certain distance threshold (towards the display, e.g. in a mobile phone). This allows the mobile phone to disable the touchscreen / turn-off the display illumination e.g. during a call to save battery power.

The setting of a user-defined hysteresis

(e.g. two threshold levels) reduces the microcontroller – sensor interaction to a minimum, thus reducing the overall power consumption.

12.4.2 Operation of the ALS

Fig. 23 illustrates a flowchart for a microcontroller based ambient light sensing. The SFH 7776 is in the free-running mode, which helps to minimize traffic on the I2C-bus as well as to relieve the microcontroller from unnecessary work load. This arrangement helps to save valuable battery power.

From time to time the ALS_VIS and ALS_IR data sets are read from the SFH 7776.

Based on the calculated ALS-ratio (= ALS_IR / ALS_VIS) and by applying subsequently the Eqs. according to Sec. 10.1, the “true” ambient light value (illumination) in front of the sensor can be calculated. These Eqs. need to be adapted in case of a dark cover glass with different spectral transmission properties (visible vs. IR) is used.

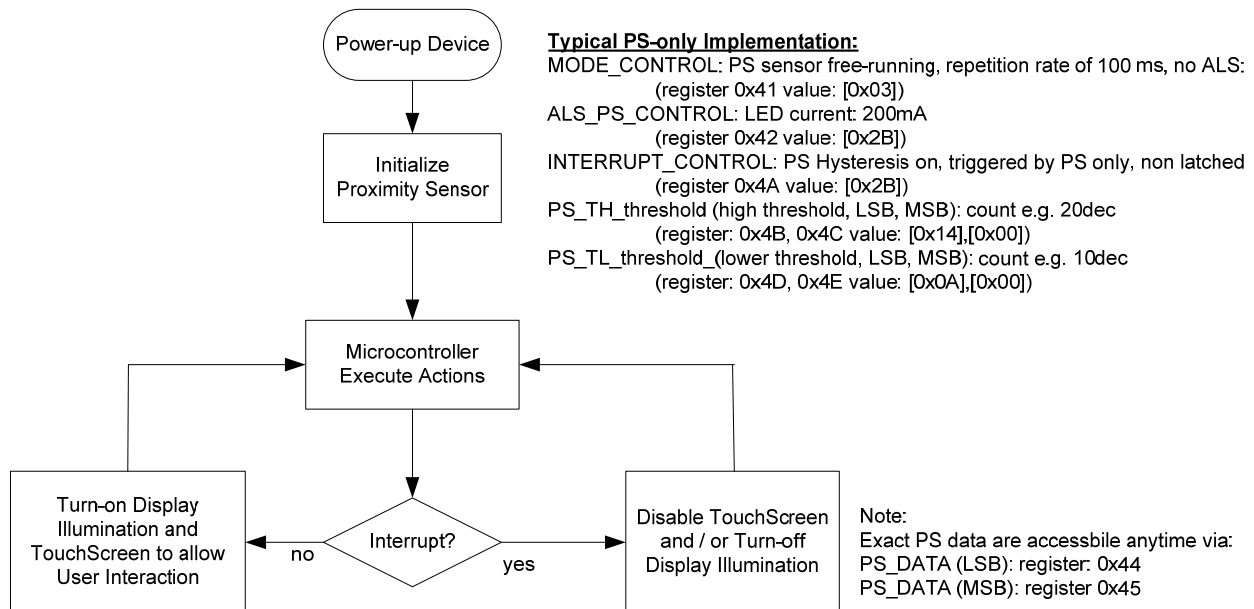

Fig. 22: Flowchart for a microcontroller based proximity sensing example.

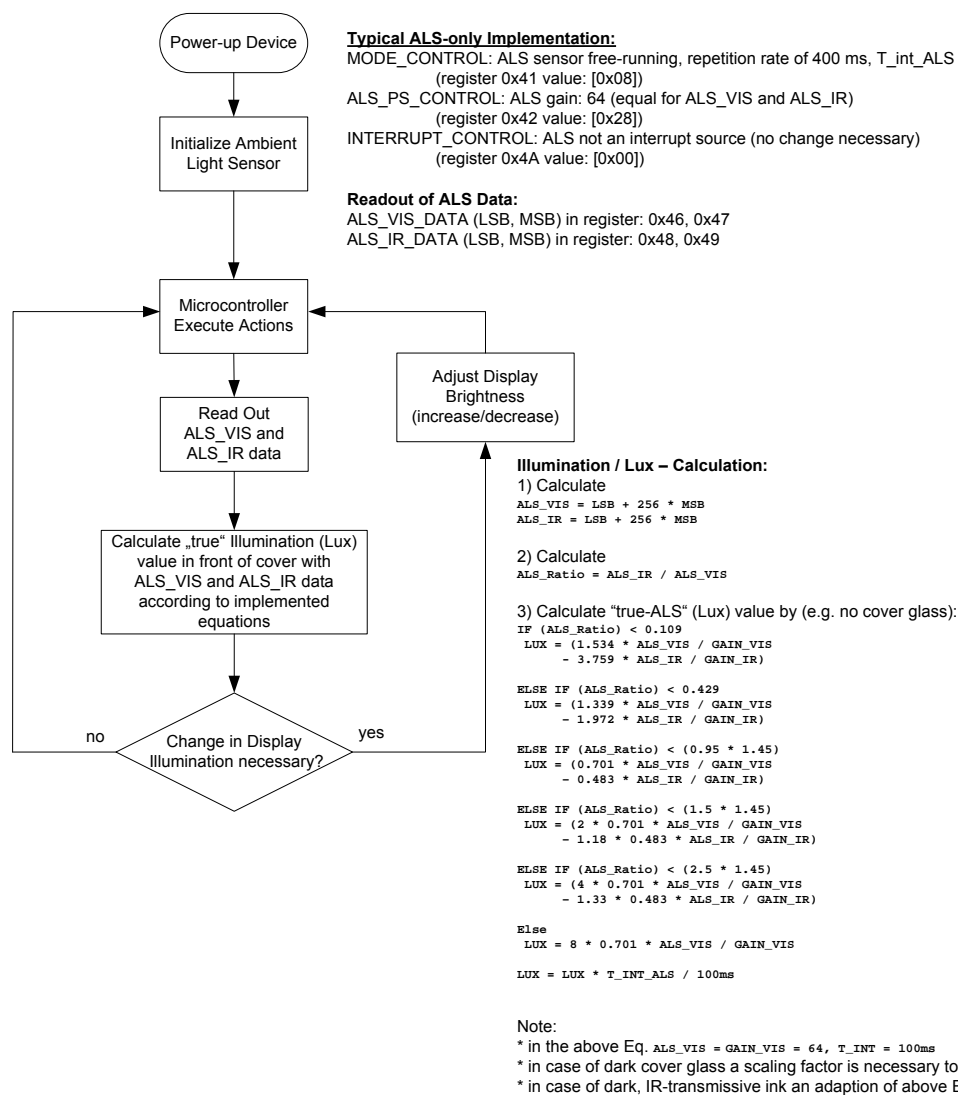

Fig. 23: Flowchart for a microcontroller based **ambient light sensing** example. After performing the ALS_IR/ALS_VIS ratio calculation the true illumination (lux) value can be directly calculated according to the Eqs. Please note that these Eqs. need to be adapted to the characteristic cover glass transmission properties (e.g. a simple gain factor to account for the attenuation if implemented behind a dark cover glass with flat transmission characteristics (visible to infrared range) or by adaption of the parameters if implemented behind dark, IR transmissive cover glasses). See Sec. 10.1 for more details.

13. Literature

[1] OSRAM-OS: <http://www.osram-os.com>.
 [2] "UM10204 I²C-bus specification and user manual" from NXP Rev. 03 – 19 June 2007

Appendix



Don't forget: LED Light for you is your place to be whenever you are looking for information or worldwide partners for your LED Lighting project.
www.ledlightforyou.com

Author: Dr. Hubert Halbritter

DISCLAIMER

This document is for information purposes only and does not represent a specification or a warranty.

All information contained in this document has been collected, analyzed and verified with great care by OSRAM Opto Semiconductors GmbH. However, OSRAM Opto Semiconductors GmbH can neither warrant the correctness and completeness of the information contained in this document nor can OSRAM Opto Semiconductors GmbH be made liable for any damage that occurs in connection with the use of and/or the reliance on the content of this document. The information contained in this report represents the state of knowledge as of April 2012 and is subjected to change without notice.

About Osram Opto Semiconductors

Osram Opto Semiconductors GmbH, Regensburg, is a wholly owned subsidiary of Osram GmbH, one of the world's three largest lamp manufacturers, and offers its customers a range of solutions based on semiconductor technology for lighting, sensor and visualisation applications. The company operates facilities in Regensburg (Germany), Sunnyvale (USA) and Penang (Malaysia). Further information is available at www.osram-os.com.

All information contained in this document has been checked with the greatest care. OSRAM Opto Semiconductors GmbH can however, not be made liable for any damage that occurs in connection with the use of these contents.