

Product Document



TAOS Inc.

is now

ams AG

The technical content of this TAOS document is still valid.

Contact information:

Headquarters:

ams AG

Tobelbader Strasse 30

8141 Premstaetten, Austria

Tel: +43 (0) 3136 500 0

e-Mail: ams_sales@ams.com

Please visit our website at www.ams.com

INTELLIGENT OPTO SENSOR DESIGNER'S NOTEBOOK



Compensating for Light Flicker on Optical Sensors

contributed by Todd Bishop
March 12, 2007

ABSTRACT

Alternating Current (AC) powered light sources have variations in light output. This variation or flicker may affect a light sensor's output, which creates unwanted variations in light measurements unless appropriate techniques are used to filter out the flicker.

OVERVIEW

A light source powered from an AC power supply, such as an incandescent or fluorescent bulb, will produce a varying light output. The magnitude of the peak to peak variation of the light source depends on several factors such as the thermal time constant for incandescent sources and the type of ballast used for fluorescent lights.

As the AC power source reaches a positive or negative peak magnitude during its sinusoidal transition, the light source will produce a peak light output. At the zero crossing of the AC line, the light will be at a minimum intensity. Because of this phenomenon, lights powered by AC sources have a flicker period that is half the period of the AC power period. This results in a light flicker frequency that is twice the frequency of the AC power frequency. This is demonstrated in Figure 1 and Figure 2 where an oscilloscope trace is shown for the output of a TAOS light to voltage (LTV) part with an incandescent and fluorescent light that is operated on 60Hz AC power.

Most parts of the world operate at either 50Hz (20ms period) or 60Hz (16.67ms period) AC power. This causes light sources such as incandescent and fluorescent bulbs to have a flicker frequency of 100Hz (10ms period) or 120Hz (8.33ms period) respectively.

Texas Advanced Optoelectronic Solutions (TAOS) provides customer support in varied technical areas. Since TAOS does not possess full access to data concerning all of the uses and applications of customers' products, TAOS assumes no responsibility for customer product design or the use or application of customers' products or for any infringements of patents or rights of others which may result from TAOS' assistance.

www.taosinc.com

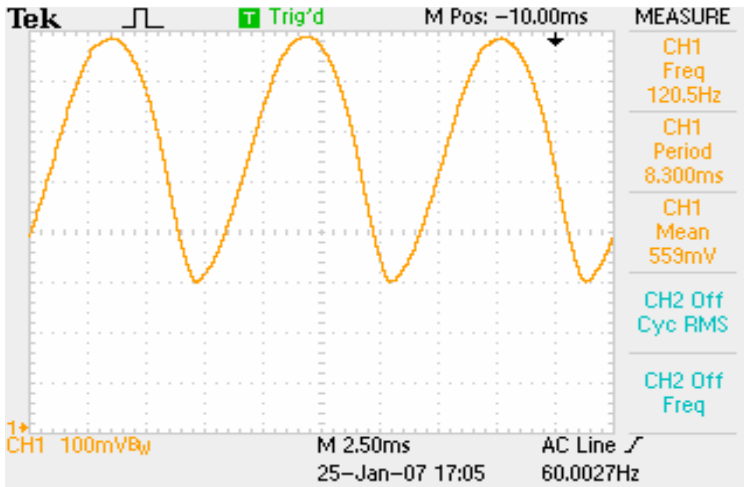

Figure 1. Fluorescent Light Flicker

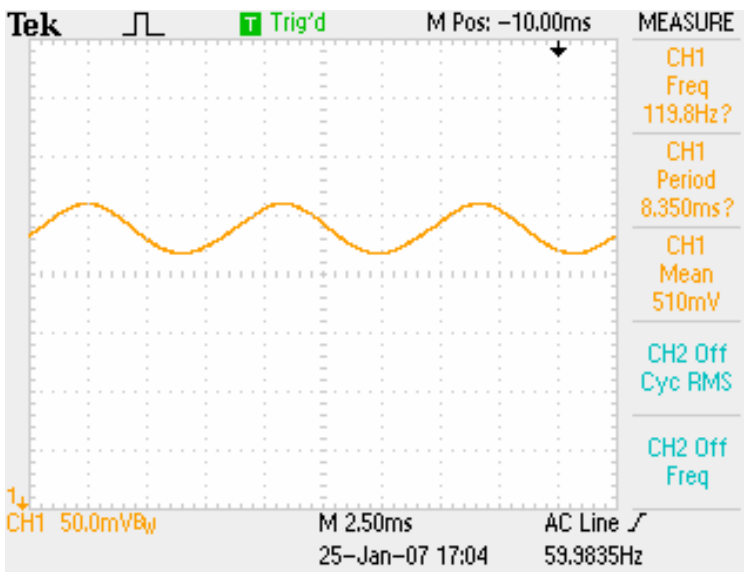

Figure 2. Incandescent Light Flicker

As can be seen from the LTV sensor output in Figures 1 and 2, the light varies at a frequency of 120Hz when powered from a 60Hz AC power supply. If the output was measured at intervals that were not integer multiples of the period, the output would appear to change between the maximum and minimum peaks. A steady measurement can be accomplished by sampling the output at multiple intervals of the period of the light flicker frequency. Since most of the world's AC power grids operate at either 50Hz or 60Hz, it is desirable to sample light at an interval that will eliminate sensor flicker regardless of which of the two power supply frequencies are used to power the light source.

Texas Advanced Optoelectronic Solutions (TAOS) provides customer support in varied technical areas. Since TAOS does not possess full access to data concerning all of the uses and applications of customers' products, TAOS assumes no responsibility for customer product design or the use or application of customers' products or for any infringements of patents or rights of others which may result from TAOS' assistance.

The minimum time to sample an integer number of flicker periods of a light source powered from either a 50Hz or 60Hz AC supply would be the minimum integer samples of 10ms and 8.33ms respectively. This occurs at 50ms, which is 5 samples of 10ms (50Hz AC), and 6 samples of 8.33ms (60Hz AC). Any sample period that is a multiple of 50ms will produce a light integration that does not include any partial periods of light flicker.

The method to remove AC light flicker from the TAOS family of light sensing products varies depending on the type of light sensor used. TAOS light sensors can be grouped into 4 categories.

TAOS Sensor Family
Light to Voltage (LTV)
Light to Frequency (LTF)
Light to Digital (LTD)
Linear Array

LIGHT TO VOLTAGE (LTV)

For the TAOS light to voltage (LTV) category of sensors, the output typically has response times much less than 250us. The LTV sensors are much faster than the periods of the light flicker frequency, so the LTV sensors produce an output that varies under AC powered light sources.

One approach to eliminate the influence of light flicker on LTV optical sensors is to slow down the output response so that the sensor does not react to the light flicker variations, and settles to a steady state level. A resistor and capacitor can be used to construct a RC delay circuit as seen in Figure 3.

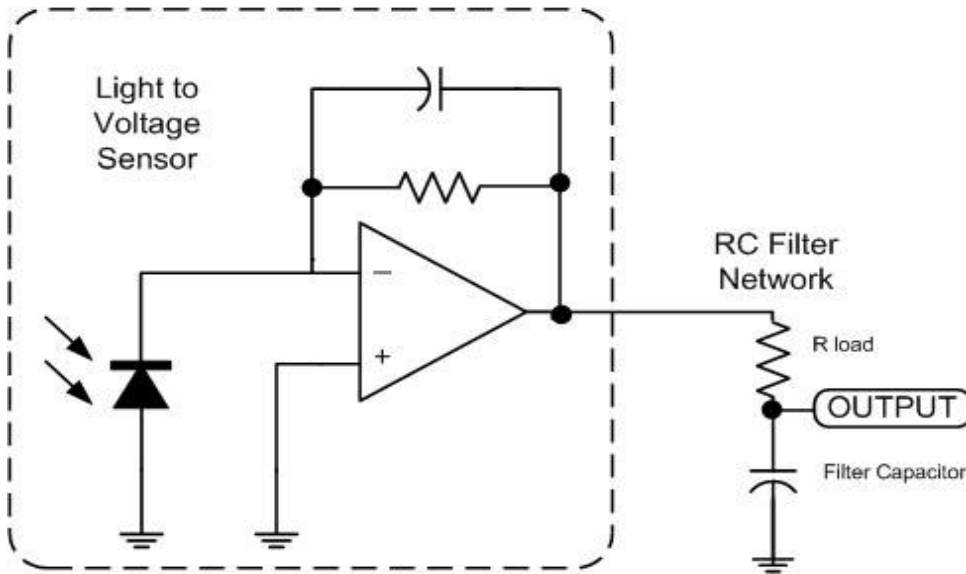

Figure 3. RC delay circuit

Texas Advanced Optoelectronic Solutions (TAOS) provides customer support in varied technical areas. Since TAOS does not possess full access to data concerning all of the uses and applications of customers' products, TAOS assumes no responsibility for customer product design or the use or application of customers' products or for any infringements of patents or rights of others which may result from TAOS' assistance.

For the configuration of a RC delay circuit in Figure 3, the time constant is set by the product of the resistor times the capacitor. See Equations 1 and 2 for time constant formulas. Simulations of a resistor with a value of 10k ohms with no filtering capacitor, 1uF, and 10uF filtering capacitors for incandescent and fluorescent light sources can be found in Figure 4 and Figure 5.

$$\tau = R * C$$

Where τ = time constant (seconds), R = resistor value (Ω), and C = capacitor value (Farads)

Equation 1. Time constant formula

$$\text{Output} = \text{Initial Value} * (1 - e^{-(t/\tau)})$$

Where τ = time constant (seconds), and t = time (seconds)

Equation 2. Exponential Curve Response formula

t / τ	% Change
1	63.2%
2	86.5%
3	95.0%
4	98.2%
5	99.3%

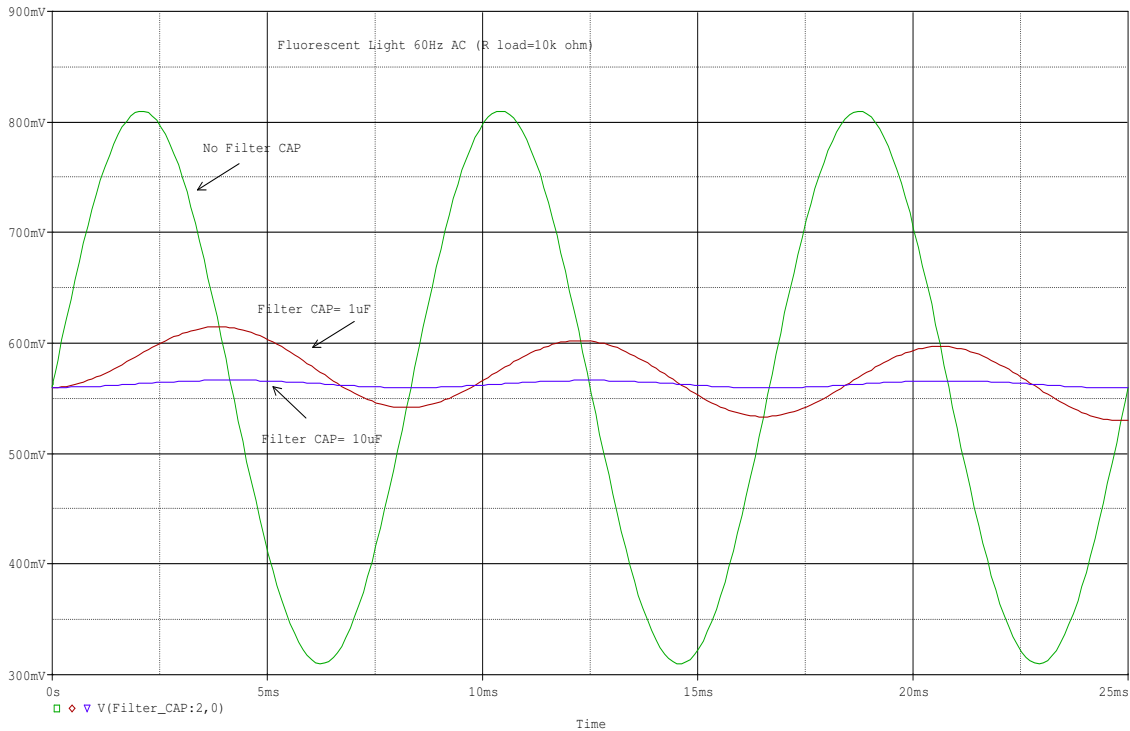

Figure 4. RC Filter Simulation with Fluorescent Light

As can be seen in the simulations of Figure 4 and Figure 5, larger values of RC products produce larger time constants that reduce the influence of light flicker on the LTV sensor output.

Texas Advanced Optoelectronic Solutions (TAOS) provides customer support in varied technical areas. Since TAOS does not possess full access to data concerning all of the uses and applications of customers' products, TAOS assumes no responsibility for customer product design or the use or application of customers' products or for any infringements of patents or rights of others which may result from TAOS' assistance.

When using this method of RC filtering to “slow” an output reacting to an unwanted change in light level, it should be kept in mind that the sensor will also be slower to a steady state (DC) change in light level as well. This can be seen in the simulation in Figure 6, that for a step change in light level, the sensor will be slow to react to a transition in light levels. It can be concluded from these simulations that a circuit that is very fast and also reduces AC light flicker are opposite in design performance goals. For this reason the application of a light sensor must always be kept in mind when designing an optical system. Please visit <http://www.taosinc.com/productfamily.aspx?sel=ltv> for more information on this family of products.

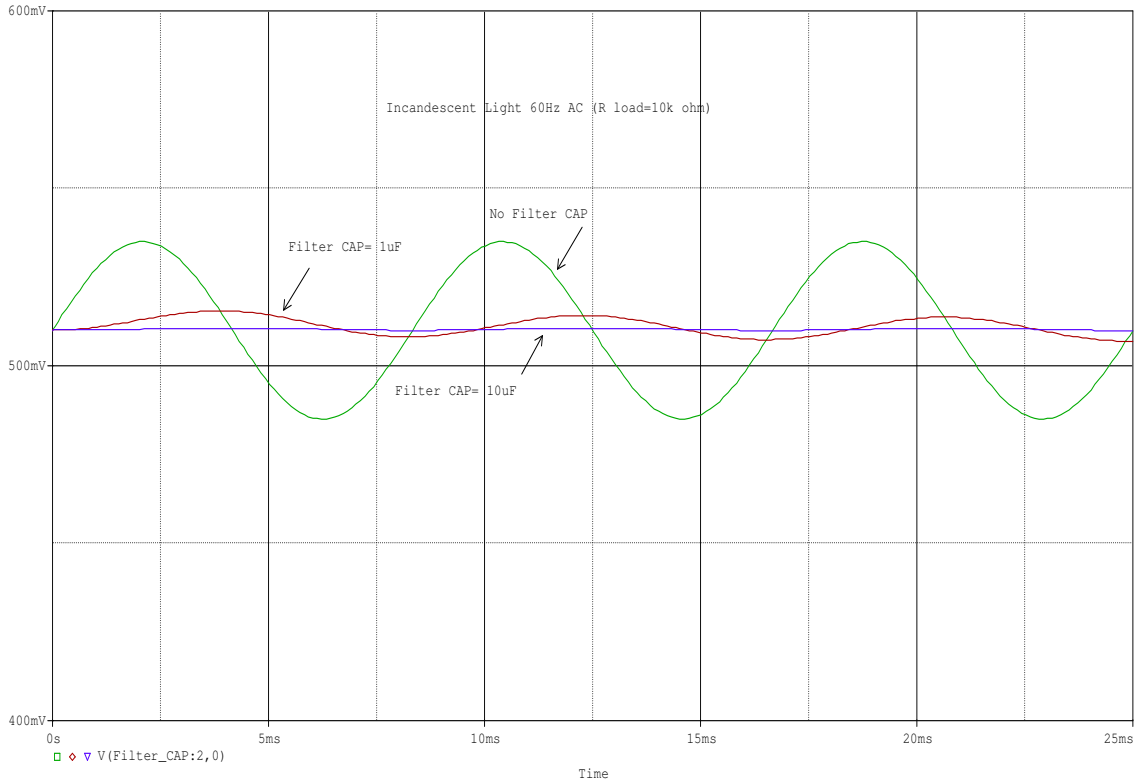

Figure 5. RC Filter Simulation with Incandescent Light

Texas Advanced Optoelectronic Solutions (TAOS) provides customer support in varied technical areas. Since TAOS does not possess full access to data concerning all of the uses and applications of customers’ products, TAOS assumes no responsibility for customer product design or the use or application of customers’ products or for any infringements of patents or rights of others which may result from TAOS’ assistance.

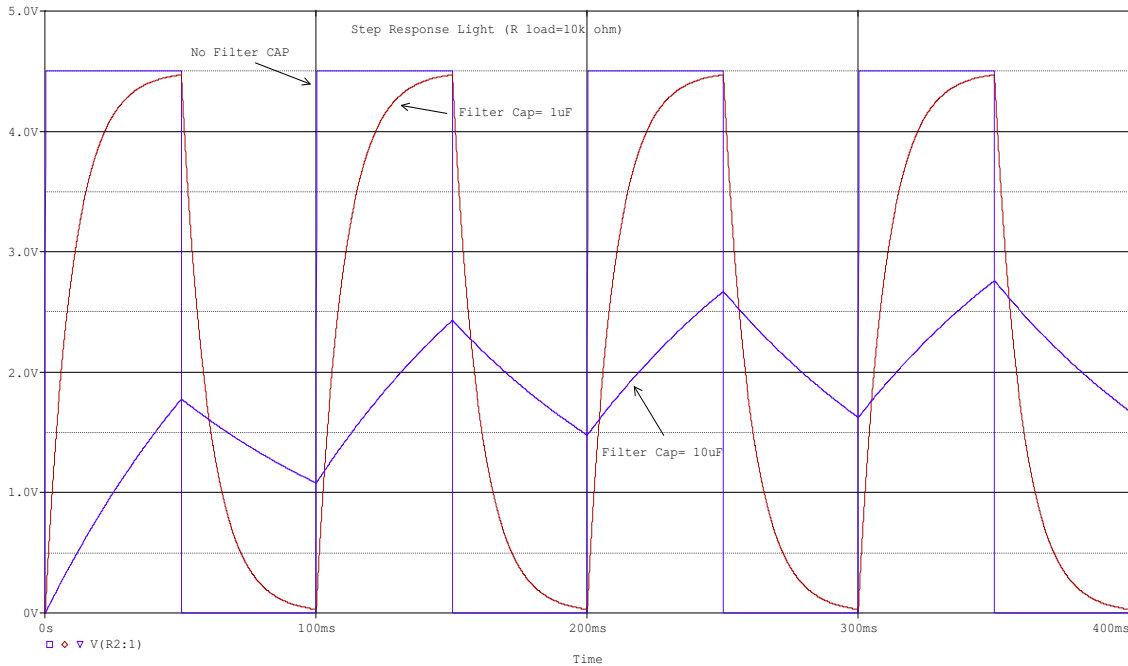

Figure 6. RC Filter Simulation with Step Function of Light

LIGHT TO FREQUENCY (LTF)

For the other categories of TAOS light sensors, the RC delay circuit is not applicable because of the output format. The frequency output sensors can not be RC filtered directly because doing so would cause the sensor output frequency to be limited. This would lower the dynamic range of the sensor considerably.

The method to reduce and eliminate flicker on the frequency, digital and linear array family of TAOS light sensors is to integrate the output over a period of time.

For the LTF family this can be accomplished by counting the frequency with a microcontroller. The interval the count takes place over sets an averaging window of time. AC light flicker will create a "jitter" frequency which will appear as a slight increase and decrease in the dominant sensor output frequency. This integration window creates an averaging in the counts from the slight frequency output change or "jitter". See Figure 7 for an example of averaging frequency with a microcontroller. Please visit <http://www.taosinc.com/productfamily.aspx?sel=ltf> for more information on this family of products.

Texas Advanced Optoelectronic Solutions (TAOS) provides customer support in varied technical areas. Since TAOS does not possess full access to data concerning all of the uses and applications of customers' products, TAOS assumes no responsibility for customer product design or the use or application of customers' products or for any infringements of patents or rights of others which may result from TAOS' assistance.

Count pulses for a given time t ...

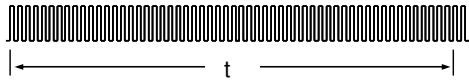

Measure time between two edges...

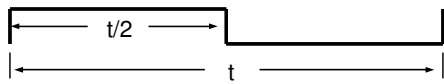

Measure time to capture n pulses...

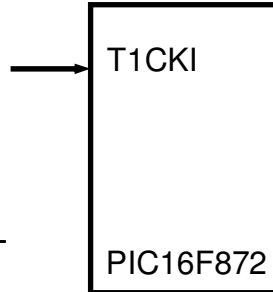
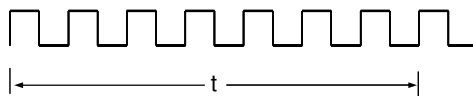

Figure 7. TAOS LTF Frequency averaging with microcontroller

LIGHT TO DIGITAL (LTD)

The TAOS light to digital (LTD) product family was designed with ambient light sensing in mind. For this reason the LTD families of parts have a built-in integration time that can be programmed on the sensor. For example the TSL256X family of LTD sensors has two recommended integration times of 100ms and 400ms to eliminate AC lighting flicker. The longer integration time of 400ms would be recommended under low light levels, while a shorter integration time of 100ms can be used when 400ms results in a saturated output level. Please visit <http://www.taosinc.com/productfamily.aspx?sel=ltd> for more information on this family of products.

LINEAR ARRAY

The linear array family of TAOS sensors has the ability to change the integration period over a wide range of times between the minimum and maximum limits. This gives the ability to synchronize the linear array integration time with the local AC power cycle period by controlling the beginning and end of the integration window to be integer multiple of the flicker frequency. For instance, a start integration (SI) input can be repeatedly looped to cause the integration time to be 50ms to eliminate light flicker frequency from a 50Hz or 60Hz AC power supply. For more information on this family of products please visit <http://www.taosinc.com/productfamily.aspx?sel=la>

CONCLUSION

AC power sources cause light sources to flicker. This flicker can create fluctuations on the output of light sensors. Several techniques have been described in this paper to compensate for this flicker and produce a stable light measurement with TAOS light sensors. Please visit www.taosinc.com for more information on all the families of TAOS light sensing products.

Texas Advanced Optoelectronic Solutions (TAOS) provides customer support in varied technical areas. Since TAOS does not possess full access to data concerning all of the uses and applications of customers' products, TAOS assumes no responsibility for customer product design or the use or application of customers' products or for any infringements of patents or rights of others which may result from TAOS' assistance.