

**OTi DALI 35/220-240/700 LT2 L**

SELV Constant current LED driver

Wide operating area up to 700 mA - dimmable

The reliable choice for the energy saving lighting:  
DALI dimmable, embedded corridor functionality  
and advanced Touch Dim with daylight harvesting,  
constant lumen output. Digitally configurable.  
Automatic current set through the LEDSet interface.

**Benefits**

Wide operating range: 200 – 700 mA  
Adjustable current via LEDset or via software.  
Zero LF ripple, mobile's camera friendly.  
Long lasting and high reliability.  
Slim white metal housing 30 x 21 mm.  
Double output connectors (parallel connection).  
Suitable for emergency lighting units.

**Applications**

Linear and area lighting.  
Office – industrial - shop

**Approval marks**

In preparation, if not already printed on product label

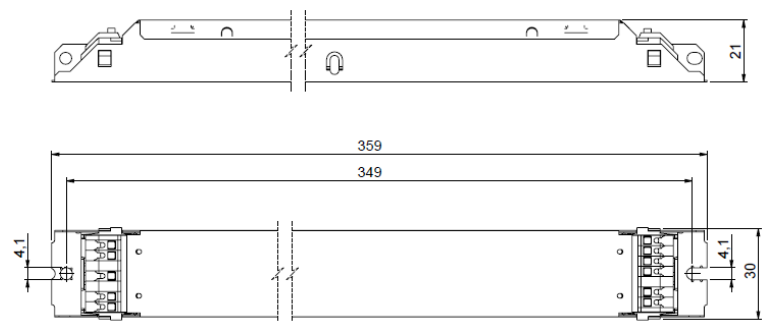
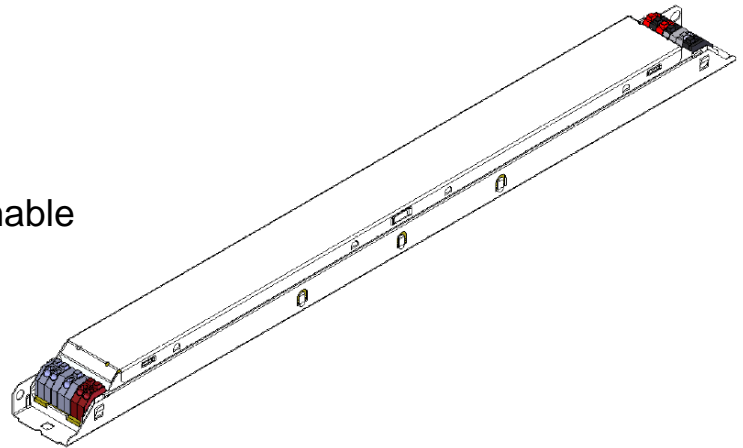

Housing material: metal, white painted.

**Product Features**

- Output current range 200 – 700 mA
- Smart dimming down to 1%
- Zero low frequency ripple
- SELV equivalent U<sub>out</sub>: 20 – 54 V
- Output power up to 37 W
- Mains voltage 220 – 240 V
- Suitable for emergency lighting
- Overload protection
- Overtemperature protection
- Fully digitally configurable
- 100'000 h lifetime at t<sub>c</sub> = 65°C
- t<sub>c</sub> max = 75 °C
- Wide t<sub>a</sub> range -25 – +60 °C
- 5 years guarantee

## Electrical Specifications

	Item	Value	Unit	Remarks
INPUT	Nominal voltage	220 – 240	V	
	Nominal frequency	0 / 50 / 60	Hz	Incl. DC or pulse DC
	AC voltage range	198 – 264	V	
	DC voltage range	176 – 276	V	DC or pulse DC
	Maximum voltage	350	Vac	2 h maximum, unit might not operate in this abnormal condition
	Nominal current	0.18	A	Full load, steady operation
	Total Harmonic Distortion (THD)	< 11	%	Full load, 220 – 240 V, 50 Hz / see graphs
	Power factor	> 0.96		Full load, 220 – 240 V, 50 Hz / see graphs
	Efficiency	Up to 90%	%	Full load, 220 – 240 V, 50 Hz / see graphs
	Power losses	4.5	W	Maximum, full load, steady operation
	No-load power	n/a	W	Load switching on output side is safe but not permitted
	Stand-by power	< 500	mW	
	Protection class	I		PE can be connected either to terminal or housing
	Inrush current	32	A pk	Max, th = 100 µs 50%
Max. units per circuit breaker	B16: 30; B10: 18		I max = 32 A Th = 100 µs	
PE current	< 0.5	mA	Through PE, output floating	
OUTPUT	Nominal voltage range	20 – 54	V	With smart power management to light up LED modules at -25°C
	Maximum voltage	60	V	No load protection, restart trials every 2-3 s
	Nominal current range	200 – 700	mA	LEDset open: 100 mA; LEDset short: 700 mA
	Current accuracy	+/- 2	%	Maximum; initial accuracy < 1%
	Current ripple	100 Hz: zero HF: 200	% mA <sub>pk</sub>	low freq. ripple is negligible High frequency ripple is constant over the output current range
	Nominal power range	4 – 35	W	Dimmable down to 0.04W
	Maximum power	37	W	
Galvanic isolation	SELV equivalent		Output and LEDset to mains - Touch current < 0.7 mA	
DIMMING	Dimming control	Yes		DALI, TouchDIM with or without sensor, Corridor functionality
	Dimming range	1 – 100	%	Of selected nominal current
	Dimming technique	mixed		1 – 26% PWM (I <sub>out</sub> < 180 mA typ.), 27 – 100% amplitude dimming
	Frequency	> 450	Hz	1 – 26% PWM dimming
	Galvanic isolation	basic / double		Basic DALI to primary-earth / Double DALI to secondary
ENVIRONMENT	Ambient temperature range t <sub>a</sub>	-25 ...+60	°C	
	Maximum case temperature t <sub>c</sub>	75	°C	Measured on t <sub>c</sub> point indicated of the product label
	Max. case temp. in fault condition	110	°C	
	Storage temperature range	-25 ...+85	°C	
	Relative humidity	5 ... 85	%	Not condensing
	Surge transient protection	1   2	kV	L/N   LN/PE acc to. EN 61547-5.7
	Environmental rating	Indoor		
	IP rating	IP 20		
	Mains switching cycles	> 100'000		
	Expected lifetime	50'000 100'000	h	t <sub>c</sub> = 75°C, 0.2% / 1'000 h failure rate t <sub>c</sub> = 65°C, 0.1% / 1'000 h failure rate

### Protections

Overtemperature, Overload, No load, Short-circuit, Input overvoltage, Output overvoltage, Output undervoltage

See remarks on page 4.

### Wiring Diagram

#### Input

- Gray 1 – Mains
- Gray 2 – Mains
- Gray 3 – n/a
- Gray 4 – PE
- White 5 – n/a
- White 6 – DALI
- White 7 – DALI

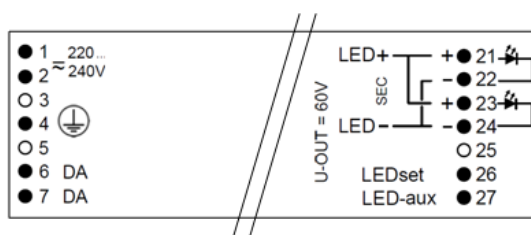

#### Output

- Red 21 – LED+
- Black 22 – LED-
- Red 23 – LED+
- Black 24 – LED-
- White 25 – n/a
- White 26 – LEDset
- Black 27 – LEDset-aux

**21 & 23 internally connected**  
**22 & 24 internally connected**

Load wires length: 2 m max

- Connectors type, both input and output: Wago 250
- Wires cross section: massive leads 0.5 – 1.5 mm<sup>2</sup> / flexible leads 0.5 – 1.5 mm<sup>2</sup>
- Wires peeling length: 8.5 – 9.5 mm

Two or more units cannot be connected together on secondary side with any or more of the 21 ... 27 terminals.

## Configuring the output current and other functionalities

### Selecting the output current

The OTi DALI 35/220-240/700 LT2 L allows the selection of the output current both through the LEDset Interface and digital programming with Tuner4TRONIC® SW:

- **LEDset interface:** connect a resistor to terminals 26 and 27. Select the resistor's value using the following chart or Rset formula. Note for terminals 26 and 27: open circuit → Iout = 100 mA; short circuit → Iout = 700 mA. Check the LEDset application note for further details and suggestions: [www.osram.com/ledset](http://www.osram.com/ledset)
- **Digital programming:** power up the unit and connect the DALI terminals to the DALI magic (USB to DALI interface), use the Tuner4TRONIC® SW (available only for OEMs upon registration on the myOSRAM portal). For further information check: [www.osram.com/t4t](http://www.osram.com/t4t)

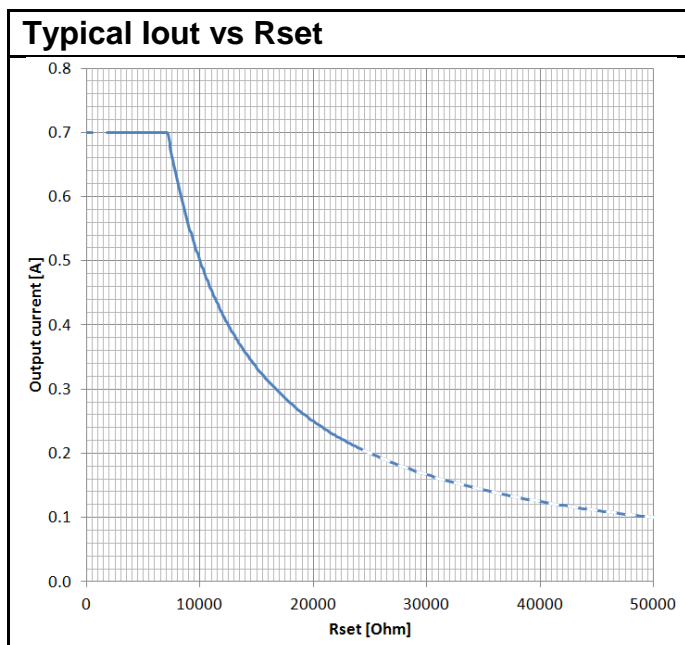

Rset formula and standard Iout values		
$I_{OUT[A]} = \frac{5V}{R_{set[\Omega]}} \times 1000$		
Iout [mA] nominal	Iout [mA] actual	Rset [kOhm] E48 series
250	255	19.6
350	357	14.0
500	500	10.0
700	700	6.81 6.8 E24 series
<b>Refer to the LEDset application note for further details.</b>		

### Configuring the unit's functionalities

All user configurable features of the OTi DALI 35/220-240/700 LT2 L can be adjusted using the Tuner4TRONIC® SW (available only for OEMs upon registration on the myOSRAM portal) and the DALI magic. For further information check: [www.osram.com/t4t](http://www.osram.com/t4t)

A subset of user configurable features and all DALI parameters can be configured using the DALI Wizard SW and DALI magic. For further information check: [www.osram.com/software](http://www.osram.com/software).

### Powering up the unit for programming

The unit must be powered up in order to enable the programming through the DALI terminals.

To improve the programming operator's safety, in place of the mains voltage, only for programming purpose, the unit can be powered up using a SELV 48 Vdc power supply, delivering the following performance:

- Output voltage range: 48Vdc -7/+20 % (44.6 - 57.6 Vdc)
- Output current: continuous 100 mA; inrush 1.5 A, 2 ms peak
- Automatic restart from overload or short circuit

Suggested SELV power supply: OPTOTRONIC OTe 25/220-240/420 CS (use 420 mA output), with cable clamps accessory.

**Important notice: OSRAM is not liable for possible wrong programming in case of use of external power supplies not compliant with the above mentioned performance requirements.**

Performance charts

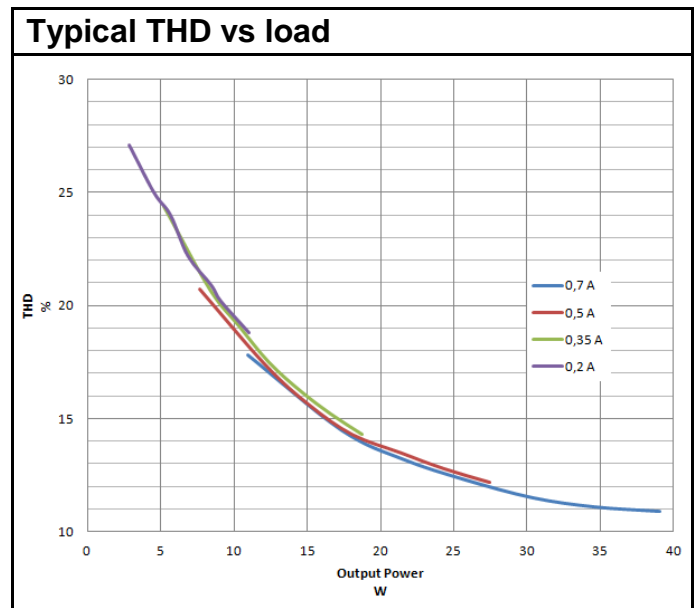
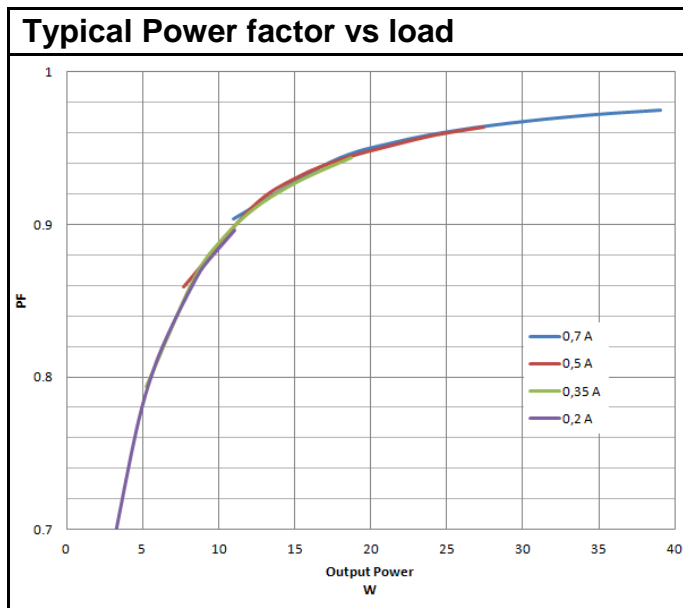
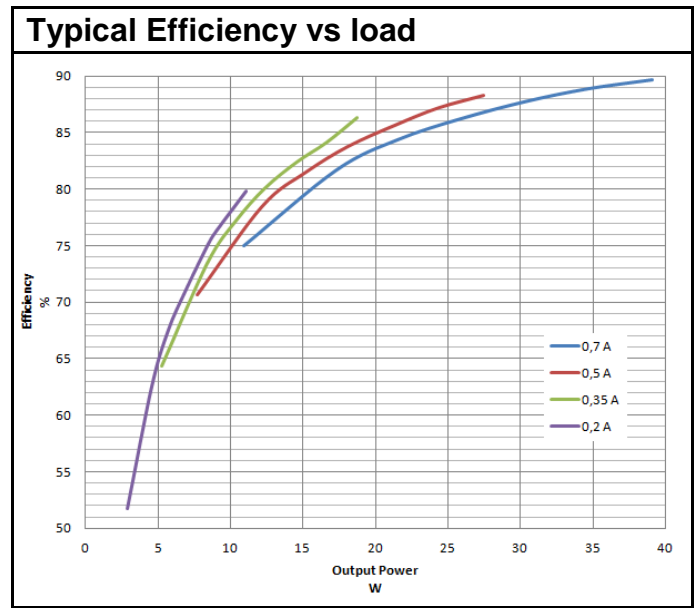
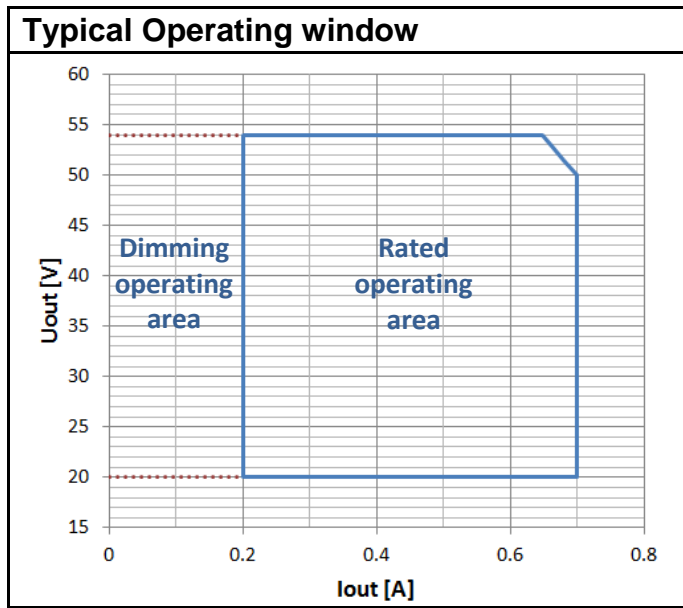

**Remarks**

- **All values have to be considered typical and measured (where applicable) in standard condition 25 °C ambient temperature.**
- **Input over voltage protection: mains up to 350 Vac**, for two hours maximum, will not destroy both the unit and the load; shut down of load might occur in this condition.
- **Output short circuit / undervoltage protection:** shut down of load happens if Uout is below 20V (typ. 15V); the unit automatically tries to switch on the load again every 2-3 s for 0.1 s delivering the selected nominal current.
- **Output overload protection:** the unit automatically reduces the output current to keep the output power below about 37 W.
- **Output over voltage protection:** the unit automatically reduces the output current to keep the output voltage below 54 V; the output current is reduced down to 180 mA typ., then the load is switched OFF. The unit automatically tries to switch on the load again every 2-3 s for 0.1 s delivering up to the selected nominal current.
- **No load operation:** the unit automatically tries to switch on the load every 2-3 s for 0.1 s delivering the selected nominal current; despite this operation mode is safe for both unit and load, it is not recommended. Do not put a switch between load and unit.
- **Over temperature protection:** the unit is protected against temporary overheating by automatic reduction of the output current when 75°C < tc < 95°C typ., and by automatic power off if 95°C < tc < 100° typ. The protection is self restoring.
- **Touch current:** lower than 0.7 mA, according to EN 60598-1 ann. G and EN 61347-1 ann. A
- **Switchover time:** lower than 0.5 s, both AC and DC mains.
- **Output power hold time:** > 4 ms, in case of mains dips.
- **Emergency lighting:** this LED power supply is suitable for emergency lighting fixtures acc. to EN 60598-2-22; EOF<sub>1</sub> = 1% - 100% according to EN61347-2-13 ann J.

**Standards**

EN 61347-1  
 EN 61347-2-13  
 EN 55015  
 EN 61547  
 EN 61000-3-2  
 EN 62384  
 EN 62386

**Ordering information**

Product name	Type	EAN10	EAN40	NAED	Pieces / box
OTi DALI 35/220-240/700 LT2 L	AA75167	4052899245389	4052899245396	n/a	20

**Manufacturer's address:**

**OSRAM GmbH**  
 Steinerne Furt 62  
 D-86167 Augsburg  
 Germany

[www.osram.com](http://www.osram.com)

**Technical support:**

Kunden Service Center Germany  
 +49 (0)89-6213-60 00